



**2022**

APP China  
Sustainability/ESG Report

---

**Live Together, Thrive Together,  
Towards Greater Mutual Prosperity**

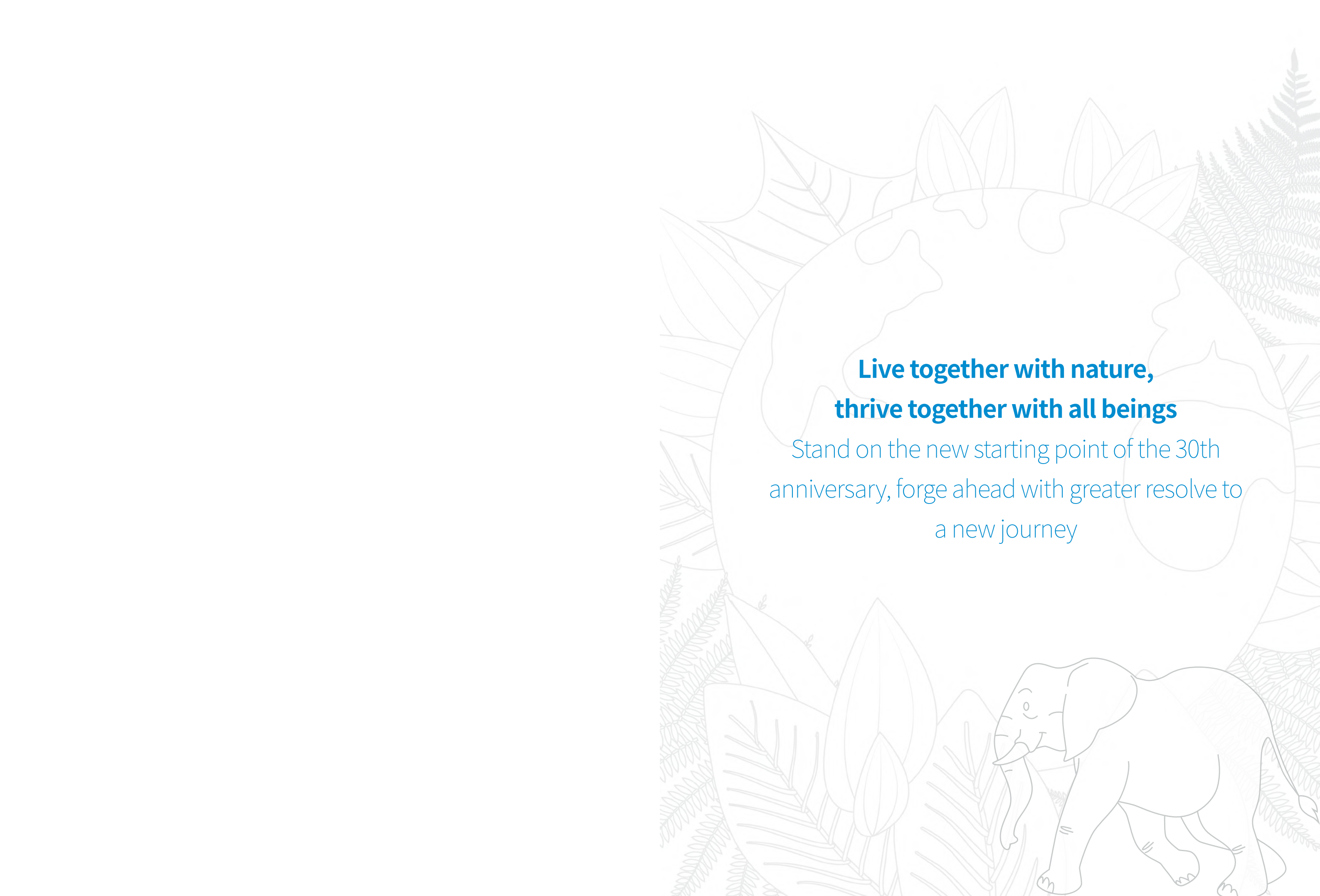

**Live together with nature,  
thrive together with all beings**

Stand on the new starting point of the 30th anniversary, forge ahead with greater resolve to a new journey

# CONTENTS

02

Message from Chairman

04

About APP China

Company Profile	04
Organizational Chart	05
Milestones	06
Achievements and Honors	08

12

Sustainability/ESG Strategy

Strategy Implementation Process	12
Sustainability Certification	14
Stakeholder Engagement	15
Materiality Assessment	18

20

Annual Focus: Protecting Our Home Planet

Practicing Circular Economy and Exploring Innovative Development Models	21
Steadily Promoting Low-carbon Transformation to Address Climate Change	29
Protecting Biodiversity and Promoting Harmony between Humanity and Nature	37

42

Environmental: Creating a Picture of Green Development

Sustainable Forest Management	44
Managing Environmental Footprint of Operations	48

58

Social: Adhering to the Original Aspiration of Shared and Win-win Development

Employee Development and Cultivation	60
Health and Safety	65
Product Responsibility	71
Customer Relationship Management	73
Charity and Philanthropy and Community Engagement	75

80

Economic and Governance: Building a Solid Foundation for Sustainable Development

Digital and Intelligent Transformation	82
R&D and Innovation	88
Risk Management	92
Business Integrity and Ethics	94
Supply Chain Management	98

100

Performance in Numbers

107

Assurance Statement

111

GRI Standards (2021) Content Index

114

TCFD Index

114

UN Global Compact Ten Principles Index

# Message from Chairman

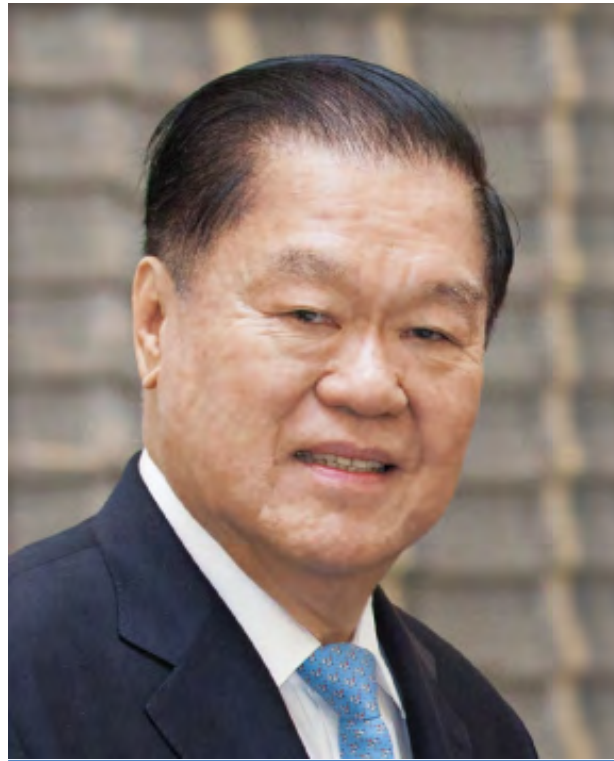

In 2022, we ushered in the 30th anniversary of Sinar Mas Group (APP)'s entry into China. As an enterprise founded by overseas Chinese, APP China is firmly connected with the development of the motherland and has been deeply rooted in China over these thirty years. Adhering to the ideal of "promoting national development with industrial development", APP China is committed to assisting the high-quality development of China's paper industry with strong entrepreneurship, from the initial introduction of the "Integration of Plantation-Pulp-Paper" development model to the current implementation of its green transformation strategy and digital and intelligent transformation strategy, aiming at promoting the symbiotic growth with the motherland and mutual prosperity with society.

Taking our "30th anniversary" as a milestone, we take the opportunity to not only reflect on where we came from, but also, more importantly, strategize our future development path in the context of the new era. Over the past three decades, China has experienced rapid economic and social development and entered a stage of high-quality development. During this period, China is not only adopting a different development mode, but also assuming greater responsibilities in the world as a great power. The report of the 20th National Congress of the Communist Party of China has set the direction for China's development with the five Chinese paths to modernization, including "the modernization of harmony between humanity and nature", "the modernization of material and cultural-ethical advancement", and "the modernization of common prosperity for all", etc., which also have a profound impact on the development patterns of enterprises.

**We regard the implementation of the green development concept as a key responsibility as a corporate citizen of our planet.** APP China has included green transformation as a core strategic direction of the Company and strives to strengthen its green and low-carbon management and innovation with a whole industry chain perspective. In 2022, we set the overall targets of carbon peaking by 2030 and carbon neutrality by 2050. Our various business units took active measures to implement carbon reduction programs, and have made a series of achievements in the fields such as forest carbon sinks, biomass energy utilization, and independent research and development of new low-carbon technologies. Our hallmark "Integration of Plantation-Pulp-Paper" industry mode will continue to play an important role in our carbon reduction strategy. As shown in the national *Carbon Peak Implementation Plan in the Industrial Field*, for the paper industry, the Integration of Plantation-Pulp-Paper industry mode is an important way to promote the industry's low-carbon coordinated development. We will continue to expand the area of plantations and carry out forest management work with strict sustainable forest management standards to ensure that forest land obtains good economic, social and ecological benefits with our plantation operations.

**We regard talent as the core force driving behind our innovation and development.** Taking digital intelligence as an example, APP China has successfully developed the Digital Intelligence 1.0 platform with the joint efforts of all employees, realizing whole-process and real-time digitalized management and monitoring of operations ranging from production, sales, logistics, and finally to customer service. During the next 2.0 stage, we will continue to work on factory automation and management process visualization, which creates greater demand for digital intelligence talents. Therefore, we plan to not only provide our employees with extensive capacity building support but also provide them plenty room to fully realize their potential. Besides, we have also intensified our research and development in the fields of sapling breeding and cultivation, product development, new technology application, and equipment transformation and upgrading, achieving both cost advantages and the scale application of technologies. In 2022, we comprehensively promoted the "dual-channel" career development

mechanism at the group level and broadened the development path of technical talents, which was well recognized by employees. Meanwhile, we continue to launch customized training programs to support the continuous capacity building and career development of our employees, allowing them to fulfill their career dreams at APP China.

**We regard "conducive to optimizing the social structure, narrowing the gap between the rich and the poor, and strengthening social stability and harmony" as one of key operating principles of the Company.** As of the end of 2022, we had donated nearly RMB1.3 billion in China, supported various disaster relief efforts and public events, and carried out a number of long-term public welfare programs in areas such as education support, youth development, and scientific research. In 2022, we added rural revitalization as a new pillar of our public welfare efforts, and carried out pilot programs in supporting development of specialty agriculture and helping farmers' grow income, making positive contribution to China's national goal of "common prosperity".

The virtuous shall have a broad path, and the self-reliant shall have divine assistance. Bearing in mind the ideal of carrying forward the Chinese papermaking civilization and serving the country with industrial development, APP China will continue to exert our spirit of self-improvement in the new journey of the next 30 years and even 100 years, strengthen innovation and development, deepen green and digital and intelligent transformation, actively align our development strategy with the national strategic goals, and stride through the many uncertainties globally with great confidence, making continuous contribution to the modernization of China.

黄志源

Chairman of Sinar Mas Group  
Teguh Ganda Widjaja



# About APP China

## Company Profile

Sinar Mas Group was founded by the prominent Indonesian Chinese Mr. Eka Tjipta Widjaja in 1938, with investments spanning continents like Asia, North and South America, Europe, and Oceania today. The Group has built seven business pillars: Pulp & Paper, Financial Services, Agri-Business & Food, Real Estate, Energy & Infrastructure, Telecommunications, and Healthcare.

Asia Pulp & Paper Co., Ltd. (APP), a pulp and paper subsidiary of Sinar Mas Group, was founded in 1972 and has grown into a world leader in papermaking industry. APP has dozens of pulp and paper companies and over one million hectares of fast-growing plantations in Indonesia, China, etc. APP's products and business spread to more than 160 countries, with businesses ranging from plantations and pulp to industrial paper, cultural paper, tissues, and various types of paper products. APP entered China in 1992.

APP's regional headquarters in China – Sinar Mas Paper (China) Investment Co., Ltd. - and its subsidiaries or other affiliated enterprises are collectively referred to as "APP China", which is the leader of pulp and paper industry in China. As of the end of 2022, APP

China had total assets totaling RMB244.5 billion and approximately 26,000 full-time employees.

APP's investment in China can be traced back to 1992. For more than 30 years, the Company has been committed to a sustainable development strategy and practiced the green and circular economy by operationalizing the "Integration of Plantation-Pulp-Paper" approach, focusing on the Yangtze River Delta and South China. The Company has invested a huge amount of money to lay out large-scale pulp and paper enterprises of world-leading level, represented by Ningbo Asia, Gold East Paper, Hainan Jinhai Pulp & Paper, Guangxi Jingui Pulp & Paper and Bohui Paper, and invested 286,000 hectares of modern fast-growing plantations.

Currently, APP China has set up multiple functional units within the Company such as Forestry Business Unit, Pulp Business Unit, Paper Business Unit, and Tissue Business Unit, and is widely involved in chemical, real estate, paper equipment, etc. In 2022, APP China's sales revenue in China was about RMB94.3 billion.

In terms of brands, APP China has many well-known trademarks, such as the household paper brand "Breeze" and "VIRJOY", the popular cultural paper brand "Space Shuttle" and "Whale King", the industrial paper brand "Jinli" and "Siji Gui", the office paper brand "Gold Flagship" and "TOPGUN", etc.

APP China actively promotes the development of sustainable urban complexes and technology parks to diversify the allocation of resources. To date, the Company has developed two large-scale urban complexes in Shanghai: the Sinar Mas Plaza and the Shanghai Arch.

### As of the end of 2022, APP China had:

Products marketed in over **160** countries/regions across **six** continents

RMB**244.5** billion in total assets

RMB**94.3** billion in annual sales revenue

## Organizational Chart

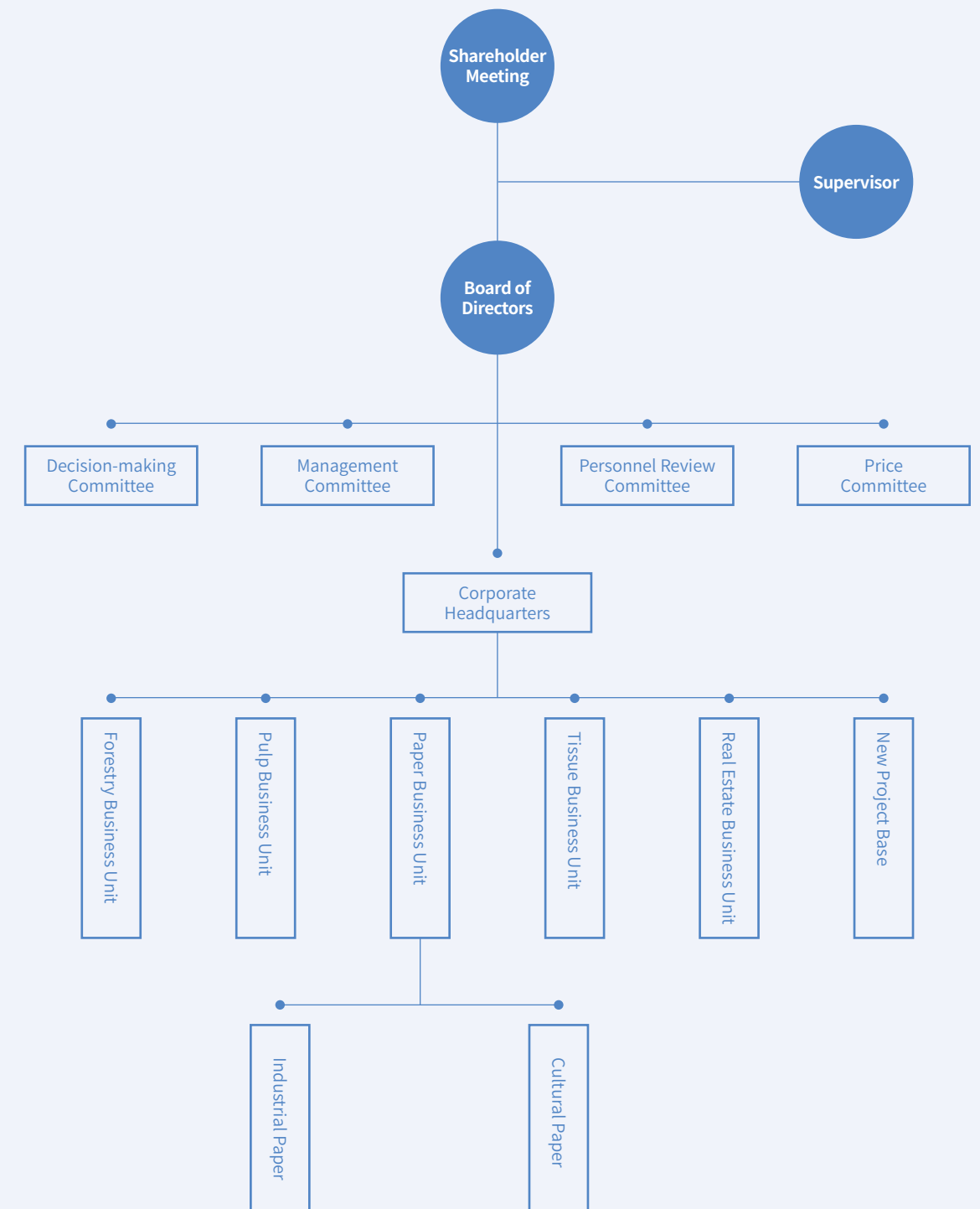

# Milestones

**1992**

Ningbo Zhonghua was formed through joint investment by APP, China Strategic Holdings Limited from Hong Kong, Ningbo Duplex Board Factory, and China Paper and Pulp Import and Export Co., Ltd. and is the first mill invested in and set up by APP in China.

**1995**

APP started to establish plantations in China, embarking on a progressive journey to modernize papermaking in the country.

**1996**

Gold Huasheng Paper (Suzhou Industrial Park) Co., Ltd. was established, and was once one of the largest diversified cultural paper product providers in China and Asia.

**1997**

Gold East Paper was officially established with a total investment of RMB20 billion; with an annual production capacity of 2 million tons of coated paper, it is one of the world's largest single-line coated paper enterprises.

**1998**

Yalong Paper Products (Kunshan) Co., Ltd. started operations; with an annual paper product capacity of 200,000 tons, it was once one of the largest paper deep-processing enterprises in China.

Gold Hongye Paper Group Co., Ltd. started operations, activating 23 fully automated assembly lines simultaneously; it currently has an annual capacity of over 1.2 million tons of tissue base paper and over 800,000 tons of finished products, and its brands such as "Breeze" and "VIRJOY" have become industry-leading tissue brands.

**2004**

Ningbo Asia Pulp & Paper was put into operation, equipped with one of the world's largest single-machine production capacities and the most advanced industrial paperboard production lines.

**2010**

With an annual chemi-mechanical pulp (CMP) production of 300,000 tons, the first phase of Guangxi Jingui Pulp & Paper's "Integration of Plantation-Pulp-Paper" project started operations, and its 600,000-ton papermaking production also started operations.

**2005**

Hainan Jinhai Pulp & Paper Co., Ltd., APP China's first pulp mill, officially started operations.

**2017**

APP China actively responded to the "Belt and Road" Initiative and signed a strategic agreement with several cities to build large-scale production and R&D bases for tissues, industrial paper, and viscose fiber using "Industry 4.0 + artificial intelligence" technologies.

**2020**

Sinar Mas Paper acquired 100% of Shandong Bohui Group's equity, optimizing corporate scale and resource allocation, and promoting orderly competition and high-quality development in China's pulp and paper industry.

The foundation stone laying ceremony of the Sinar Mas Group Yancheng Cellulose Fiber Integration Industrial Base was held at the Binhai Port Industrial Park, Yancheng, Jiangsu Province.

**2022**

On the occasion of its 30th anniversary of entering China, the Company integrated an ESG development concept into its sustainability strategy and released the first ESG report at the 5th China International Import Expo.

**2021**

The Sinar Mas - APP Rudong Tissue Base started operations with a total investment of RMB45 billion, a planned site area of 567 hectares, and an annual high-grade tissue production capacity of 3.96 million tons. It was divided into three phases of construction, and the first phase of the project has been fully completed and put into production currently.

# Achievements and Honors

Receiver	Honors and Awards	Issuers
APP China	2021 Green Exemplary Annual Award	The 11th Public Welfare Festival and Corporate Social Responsibility Carnival
	The Fourth Outstanding Overseas Chinese-funded Enterprises in Jiangsu Province	The Federation Of Jiangsu Returned Overseas Chinese, Department of Commerce of Jiangsu Province, Jiangsu Provincial Tax Service, China Council for the Promotion of International Trade Jiangsu Sub-council, Jiangsu Chamber of International Commerce, Jiangsu Overseas Chinese Enterprise Federation
	2022 ESG Practice Model Award	The 11th Finance Summit Sustainable Business Conference · 2022
	2022 Responsible Enterprise	The 18th China Corporate Social Responsibility Forum
	HONOUR 2022 Enterprises Contributing to Sustainable Development	The 5th Social Responsibility Conference
Hainan Jinhai Pulp & Paper	2021 Outstanding Enterprises Contribution to Hainan Science and Technology Industry Development	Hainan Science and Technology Enterprise Federation, Hainan Science and Technology Industry Federation Trade Union Committee, Hainan Sina Internet Information Service Co., Ltd.
	2022 Outstanding Unit of Emergency Management	Yangpu Economic Development Zone Management Committee
	Donation with Love, and Care for Communities	Ganchong Work Committee of Danzhou Municipal Committee of CPC, Ganchong Office of Danzhou Municipal People's Government
	2022 Top 100 Enterprises in Hainan Province (No. 15), 2022 Top 40 Enterprises of Manufacturing Industry in Hainan Province (No. 4)	Hainan Enterprise Confederation, Hainan Entrepreneur Association
	2022 Top 50 Private Enterprises in Hainan Province (No. 3)	Federation of Industry and Commerce of Hainan Province
	2022 Top 20 Private Enterprises in Hainan Province for R&D Investment (No. 3)	Federation of Industry and Commerce of Hainan Province, Science and Technology Department of Hainan Province
	2022 Outstanding Enterprises Based on Survey of Purchasing Managers	Hainan Provincial Survey Organization of National Bureau of Statistics of China
	2022 Pilot Enterprises of Industrial Wastewater Recycle and Reuse	Administration Office of Ministry of Industry and Information Technology
Gold East Paper	The Third Batch of "Water Efficiency Front-runner" in Jiangsu Province	Jiangsu Provincial Water Resources Department, Jiangsu Development & Reform Commission, Industry and Information Technology Department of Jiangsu, Department of Finance of Jiangsu Province, Jiangsu Provincial Department of Housing and Urban-Rural Development, Jiangsu Provincial Market Supervision Administration, Jiangsu Provincial Government Offices Administration
	2021 Top 10 Papermaking Enterprises in China's Light Industry, Top 200 Enterprises in China's Light Industry	China National Light Industry Council, China Paper Association
	2022 Leading Green Development Enterprises in Jiangsu Province	Department of Ecology and Environment of Jiangsu Province, Federation of Industry and Commerce of Jiangsu Province
	2022 Advanced Unit for China Light Industry Digital Transformation	China National Light Industry Council
	2021 Outstanding Labor Relations and Harmonious Enterprise in Jiangsu Province	Tripartite Committee for Coordinating Labor Relations of Jiangsu Province
2021 Top 10 Enterprises for Tax Contributions in Zhenjiang New Area	CPC Zhenjiang New Area Work Committee, Zhenjiang New Area Management Committee	

Receiver	Honors and Awards	Issuers
Gold East Paper	2021 Golden Mountain Award	CPC Zhenjiang Municipal Committee, Zhenjiang Municipal People's Government
	2022 Top 100 Enterprises in Jiangsu, 2022 Top 100 Manufacturing Enterprises in Jiangsu	Jiangsu Provincial Enterprise Federation
	2022 Green Front-runner Enterprises	China Environmental United Certification Center (CEC)
	Products of Green Raw & Auxiliary Materials	The Printing Technology Association of China
	2022 Pilot Enterprises of Industrial Wastewater Recycle and Reuse	Ministry of Industry and Information Technology of the People's Republic of China
	2022 Top 20 Paper Enterprises in China	China Pulp and Paper Industry Magazines Publisher
Guangxi Jingui Pulp & Paper	Top 500 Enterprises of China's Manufacturing Industry	China Enterprise Confederation
	National "Green Factory"	Ministry of Industry and Information Technology
	2021 Stepping Up Industrial Enterprises above Designated Size	Industry and Information Technology Department of Guangxi Zhuang Autonomous Region
	The Fourth Qin Zhou Mayor Quality Award	Qin Zhou Municipal People's Government
	2021 Top 30 National Key Papermakers for Output	China Paper Association
	Guangxi Pilot Enterprises for RCEP Promotion and Implementation	Guangxi Council for the Promotion of International Trade
	Top 10 Papermaking Enterprises of China's Light Industry	China National Light Industry Council, China Paper Association
	Demonstration Enterprises for Quality Improvement in Guangxi	Market Supervision Administration of Guangxi Zhuang Autonomous Region
	Top 20 Paper Enterprises in China	China Pulp and Paper Industry Magazines Publisher
	Second Prize of Best Practice on Applying RCEP Agreement on Market Expansion by Guangxi's Local Enterprises	Department of Commerce of Guangxi Autonomous Region, Department of Industry and Information Technology of Guangxi Autonomous Region, Nanning Customs District P.R.China, Guangxi Council for the Promotion of International Trade
Ningbo Asia	Nomination Award for the 6th Guangxi Zhuang Autonomous Region Chairman Quality Award	People's Government of Guangxi Zhuang Autonomous Region
	2022 Pilot Enterprises of Industrial Wastewater Recycle and Reuse	Administration Office of Ministry of Industry and Information Technology
	2021 "Contract Abiding and Trustworthy" Enterprise of Guangxi	Market Supervision Administration of Guangxi Zhuang Autonomous Region
	Top 100 High-Tech Enterprises in Guangxi	Guangxi Zhuang Autonomous Region Science and Technology Information Research Institute, Guangxi High-tech Enterprise Association
	2021 Top 50 Tax Contributors of Ningbo's Manufacturing Industry	Ningbo Municipal People's Government
Ningbo Asia	2021 First Batch of "Zero Waste City Cells" in Ningbo	Ningbo Office of the Leading Group for Building a Beautiful Ningbo
	2022 Qualification for Beilun District Science Popularization Base	Beilun District Association for Science and Technology of Ningbo
	2021 Five-Star Enterprise for Business Management Innovation and Improvement in Ningbo	Ningbo Municipal Economic and Information Technology Bureau



Receiver	Honors and Awards	Issuers
Ningbo Asia	Top 10 Papermaking Enterprises of China's Light Industry (No. 8)	China National Light Industry Council, China Paper Association
	2022 Top 100 Competitive Enterprises in Ningbo (No. 50), 2022 Top 100 Manufacturing Enterprises in Ningbo (No. 29), 2022 Top 100 Comprehensive Enterprises in Ningbo (No. 48), Top 100 Fastest-growing Enterprises in Zhejiang Province	Ningbo Enterprises Confederation, Ningbo Entrepreneur Association, Ningbo Federation of Industrial Economics
	Charity Model in Beilun District	Ningbo Beilun Charity Federation
Bohui Paper	2022 Advanced Unit for Digital Transformation in China's Light Industry	China National Light Industry Council
	2022 Top 20 Paper Enterprises in China	China Pulp and Paper Industry Magazines Publisher
	2022 National Intellectual Property Advantage Enterprises	China National Intellectual Property Administration
	2022 Top 500 Private Enterprises in R&D Investment, China Top 500 Private Manufacturing Enterprises	All-China Federation of Industry and Commerce
	2021 Top 10 Enterprises	Shandong Paper Association
	AAA Grade Enterprise Credit Certificate	Shandong Enterprise Confederation, Shandong Federation of Industrial Economics
	2022 Smart-manufacturing Demonstration Plants of Shandong Province, Shandong Provincial Industrial Internet Benchmarking Factory	Department of Industry and Information Technology of Shandong Province
	2022 Top 100 Private Enterprises in Shandong, 2022 Top 100 Private Enterprises in Shandong in Terms of Employment Absorption	Federation of Industry and Commerce of Shandong Province
	First Prize of "Lean Management Capability Six Aspects of Improvement - Lean Site Management Achievement Competition", Advanced (Three-star) Unit of Shandong Province for Equipment Management	Shandong Association of Plant Engineering
	Shandong Enterprise Technology Center	Shandong Development and Reform Commission
	2022 Shandong Famous Brands & Products	Shandong Council for Brand Development
	2022 "One Enterprise, One Technology" R&D Center for Industrial Enterprise, Zibo City	Zibo Industry and Information Technology Bureau
	Zibo Engineering Research Center for New Materials for Papermaking	Zibo Development and Reform Commission
	Qualification for "Self-evaluation of Enterprise Skilled Talents"	Zibo Public Employment and Talent Service Center
	Jiangsu Provincial "Green Factory", Smart-manufacturing Demonstration Plants of Jiangsu Province	Industry and Information Technology Department of Jiangsu Province
Postgraduate Research Station in Jiangsu Province	Jiangsu Education Department and Jiangsu Provincial Department of Science and Technology	
2021 Five-star Enterprise of Star-Excellence	Yancheng Municipal People's Government	
High-tech Products Recognition, Yancheng Engineering and Technology Research Center Recognition	Yancheng Science and Technology Bureau	
2021 Tax Contribution Award over RMB100 Million	Committee of the CPC Dafeng District and People's Government of Dafeng District, Yancheng City	

Receiver	Honors and Awards	Issuers
Gold Hongye Paper	2021 Annual Outstanding Economic Contribution Award - Top 30 Headquarters Economies	CPC Suzhou Industrial Park Work Committee, Suzhou Industrial Park Management Committee
	National Model Enterprise for Trustworthy Product and Service Quality, Stable and Qualified Products in National Quality Inspection, National Quality Credit Guaranteed Products for Consumers, National Leading Brand of Product and Service Quality Integrity, Top-Quality Brand of China's Tissue Industry, Top-Quality Enterprise of China's Tissue Industry, China Quality Credit Model Enterprise	China Association for Quality Inspection
	2022 Annual Craftsmanship Product in China Tissue Industry ("Breeze")	China Technical Association of Paper Industry
	2022 Green Model Award for Tissue Industry	2022 International Green Zero-Carbon Festival
	2022 Most Influential Green Enterprise Brand ("Breeze")	Xinhuanet
	2022 TBI Brand of the Year Household Cleaning and Chemical Industry (Gold Hongye Paper), 2022 TBI Best ESG Brand (VIRJOY), 2022 TBI Best Environmentally Friendly Sustainable Product (VIRJOY)	TBI Organizing Committee
	The 6th DMAA International Digital Marketing Award Gold Prize ("The Breeze Exploration Journey")	The 6th DMAA International Digital Marketing Summit
	The 29th China International Advertising Festival Integrated Marketing Award ("The Breeze Exploration Journey")	Advertiser Ceremony Organizing Committee
	Like 2022 My Favorite Chinese Brand (Breeze)	China National Brand
	National "Green Factory" (Gold Hongye Hubei Mill)	Ministry of Industry and Information Technology
Hainan Gold Hongye	2022 Top 100 Enterprises in Hainan Province (No. 39), 2022 Top 40 Enterprises of Hainan Manufacturing Industry (No. 9)	Hainan Enterprises Federation, Hainan Entrepreneurs Association
	Outstanding Unit for Energy Conservation and Emission Reduction	Hainan Energy Conservation and Emission Reduction Association
Hainan Gold Shengpu	Pioneer Unit for Energy Conservation and Emission Reduction	Hainan Energy Conservation and Emission Reduction Association
Rudong Base	2021 Major Project High-Quality Construction Award of the City - Top 10 Projects for Foreign Investment Attraction	CPC Nantong Municipal Committee, Nantong Municipal People's Government
	New Overseas Chinese Innovation and Entrepreneurship Base	Jiangsu Overseas Chinese Federation
APP China Forestry	Hainan Science and Technology Innovation Project Award	Hainan Provincial Federation of Science and Technology Enterprises, Hainan Provincial Federation of Science and Technology Industry Union Committee, Sina Hainan
	Provincial Leading Forestry Enterprises	Jiangxi Provincial Department of Forestry



# Sustainability/ESG Strategy

## Strategy Implementation Process

APP's "Sustainability Roadmap: Vision 2030" ("SRV 2030") focuses on three core issues - energy saving and emission reduction, forest conservation, and community development, with three overall goals respectively, which are "30% reduction in carbon footprint", "over half a million hectares of natural forests conserved", and "improve

the lives of millions". Based on these, APP China formulated its own 2030 Sustainability Strategy in 2021 based on local conditions. In 2022, we formulated the APP China Carbon Peaking and Carbon Neutrality strategic plan, making another positive progress in advancing our sustainability strategic goals.



### Progress Towards Realizing APP China 2030 Sustainability Strategic Goals

Goals	Peak carbon emissions by 2030	Contribute to APP's goal of "over half a million hectares of natural forests conserved"	Undertake forest carbon sink projects	Adjust energy structure in mills	30% reduction in product carbon footprint	Continuously promote "carbon neutral" products	Contribute to APP's goal of "improve the lives of millions"	Fully advance ESG-related practices, deliver on the three-year ESG roadmap, and continuously improve ESG performance
Annual Progress	The formulation of the implementation roadmap of the "carbon peaking by 2030, and carbon neutrality by 2050" strategy is near completion.	Further increased the area of our plantations to 286,000 hectares, a 5.7% increase compared to 2021.	By the end of 2022, the carbon storage capacity of our plantations reached 44.84 million tons of carbon dioxide, which were preliminarily identified as eligible for VCS projects and CCER projects. Relevant pilot projects were planned to be implemented in the next two years.	We intensified the utilization of photovoltaic energy and biomass energy, and increased the purchase of green electricity, with our solar power generation and biomass energy use increased by 27.11% and 10.5% year-on-year respectively.	The carbon intensity of our pulp and paper products decreased by 7% compared to 2021.	Gold Hongye Paper introduced the Breeze Blossom Zero-carbon Floral Essence Premium Roll Tissue, and VIRJOY zero-carbon tissue; Bohui Paper's white ivory cardboard, cultural paper, and packaging paper products had passed carbon neutral certification.	Based on extensive field research, we initiated a pilot rural revitalization project in Ganzhou, donating and supporting the development of a navel orange cultural and tourism industry park to promote the development of local specialty industries.	We carried out ESG capacity building activities, organizing a series of sustainability/ESG thematic training at headquarters and various business units, covering sustainability trends, key ESG ratings, ESG risk and opportunity management, carbon asset management, etc.
Contribution to SDGs	7, 12, 15	11, 12, 13, 15	11, 12, 13, 15	7, 9, 11, 12, 13, 14, 15	7, 9, 11, 12, 13, 14, 15	7, 9, 11, 12, 13, 14, 15	1, 3, 8, 11, 12, 17	11, 12, 16



## Sustainability Certification

### CFCC/PEFC-FM Certification\* of APP China Forestry

No.	APP China Forestry Companies	Certificate No.
1	Hainan Jinhua Forestry Co., Ltd.	CFCC/PEFC-FM-ZTFC-000003
2	Heyuan Jinmei Science & Technology Forestry Co., Ltd.	CFCC/PEFC-FM-ZTFC-000030
3	Leizhou Jin-taiyang Science and Tech Forestry Ltd.	CFCC/PEFC-FM-ZTFC-000030
4	Yangjiang Jin-taiyang Science and Tech Forestry Ltd.	CFCC/PEFC-FM-ZTFC-000030
5	Jin-Qingyuan Timberland (Paper mill) Ltd.	CFCC/PEFC-FM-ZTFC-000007
6	Shaoguan Jin-Shaoguan First Quality Timberland (Paper mill) Ltd.	CFCC/PEFC-FM-ZTFC-000008
7	Guangxi Jin Gui Forestry Co., Ltd.	CFCC/PEFC-FM-ZTFC-000005
8	Guangxi Jin Qinzhou High-Yield Forestry Co., Ltd.	CFCC/PEFC-FM-ZTFC-000006
9	Guangxi Xing Guilin Agriculture Technology Co., Ltd.	CFCC/PEFC-FM-ZTFC-000031
10	Guangxi Jin Taiyang Forestry Co., Ltd.	CFCC/PEFC-FM-ZTFC-000031
11	Wenshan Jin Wenshan High-Yield Forestry Co., Ltd.	CFCC/PEFC-FM-ZTFC-000017
12	Simao Jin Lancang High-Yield Forestry Co., Ltd.	CFCC/PEFC-FM-ZTFC-000018

\*CFCC/PEFC-FM certification refers to CFCC/PEFC Forest Management certification.

### 2022 Main Sustainability Management System Certification Audit Status at Mills of APP China

	ISO9001	ISO14001	ISO45001	ISO50001	CFCC/PEFC-CoC*
Gold East Paper	Periodic audit	Re-certificate audit	Re-certificate audit	Periodic audit	Re-certificate audit
Ningbo Asia	Periodic audit	Periodic audit	Periodic audit	-	Re-certificate audit
Hainan Jinhai Pulp & Paper	Periodic audit	Periodic audit	Periodic audit	Periodic audit	Periodic audit
Guangxi Jingui Pulp & Paper	Periodic audit	Periodic audit	Periodic audit	-	Re-certificate audit
Shandong Base of Bohui Paper	Periodic audit	Periodic audit	Periodic audit	Periodic audit	Periodic audit
Jiangsu Base of Bohui Paper	Re-certificate audit	Initial audit	Initial audit	Re-certificate audit	Periodic audit
Rudong Base	Periodic audit	Initial audit	Initial audit	Initial audit	Periodic audit

\*CFCC/PEFC-CoC certification refers to CFCC/PEFC Chain of Custody certification.

## Stakeholder Engagement

We have established a regular communication mechanism with stakeholders through various channels to fully understand their expectations and demands, and continuously refine our management measures and practices based on actual operational situations in response to key issues of concern of our stakeholders.

In 2022, APP China actively participated in the formulation of a series of national and industry standards. The standards officially released in 2022 include the group standard for *Evaluation Specification of Zero-Carbon Factory* (T/CECA-G 0171-2022), the group standard of *Enterprise ESG Evaluation System* (T/CERDS 3-2022), the national standard of *Tissue* (GB/T 20808-2022), the group standard of *Products with Craftsmanship—Tissue Paper* (T/CTAPI 002-2022), the national standard of *Hand Towel* (GB/T 24455-2022), etc.





### Co-hosting the 11th China Paper Industry Sustainable Development Forum





From September 16 to 18, 2022, APP China co-hosted the China Paper Industry ESG Development Strategy Forum and Sinar Mas Group APP China's 30th Anniversary Celebration in Ningbo, in collaboration with China National Pulp and Paper Research Institute, China Technical Association of Paper Industry (CTAPI), and China Pulp and Paper Magazines Publisher. It has been the 11th annual series of events of the China Paper Industry Sustainable Development Forum initiated by APP China since 2008. More than 100 industry experts, scholars, and representatives

from enterprises and media participated in-person or online in a number of discussions and forums on topics such as "High-quality Development of China's Paper Industry in the Context of China's Carbon Peaking and Carbon Neutrality Goals", "Digital Transformation and Upgrading of the Paper Industry", "Industry-University-Research Cooperation Model in the Paper Industry", "ESG Development at Paper Enterprises", "ESG Investment and Corporate Carbon Asset Rating", and "ESG Investment and Corporate Value".



Site of "the China Paper Industry ESG Development Strategy Forum and Sinar Mas Group APP China's 30th Anniversary Celebration"

Stakeholders	Top Concerns		Engagement Channels	
<b>Employees</b> 	<ul style="list-style-type: none"> <li>Product quality and safety</li> <li>Occupational health and safety</li> <li>Water resources management</li> </ul>	<ul style="list-style-type: none"> <li>Business ethics</li> <li>Economic performance</li> </ul>	<ul style="list-style-type: none"> <li>Company internal magazine</li> <li>APP Culture Voice platform</li> <li>Employee representative meetings</li> <li>Employee communication meetings</li> <li>Executive mailbox</li> <li>MBOS proposal competition</li> </ul>	<ul style="list-style-type: none"> <li>Sunshine Integrity Month</li> <li>Training activities on different topics</li> <li>Diversified employee activities</li> <li>Sustainability reports</li> <li>WeChat Official Account</li> <li>Integrity and compliance whistleblowing channel</li> </ul>
<b>Customers and consumers</b> 	<ul style="list-style-type: none"> <li>Product quality and safety</li> <li>Business ethics</li> <li>Economic performance</li> </ul>	<ul style="list-style-type: none"> <li>Customer relationship management</li> <li>Circular economy</li> </ul>	<ul style="list-style-type: none"> <li>Customer visits</li> <li>Engagement meetings</li> <li>Little A Classroom</li> <li>Industry conferences/ events</li> <li>Customer satisfaction surveys</li> </ul>	<ul style="list-style-type: none"> <li>Customer service hotline/mail</li> <li>Company website</li> <li>Sustainability reports</li> <li>WeChat Official Account</li> </ul>
<b>Suppliers/Contractors</b> 	<ul style="list-style-type: none"> <li>Product quality and safety</li> <li>Business ethics</li> <li>Customer relationship management</li> </ul>	<ul style="list-style-type: none"> <li>Economic performance</li> <li>Water resources management</li> </ul>	<ul style="list-style-type: none"> <li>Supplier/Contractor meetings</li> <li>Supplier/Contractor training</li> <li>Cooperative R&amp;D mechanism</li> <li>Regular supervision and inspection</li> </ul>	<ul style="list-style-type: none"> <li>Sustainability reports</li> <li>Supplier performance evaluation</li> <li>Integrity and compliance whistleblowing channel</li> </ul>
<b>Banks</b> 	<ul style="list-style-type: none"> <li>Economic performance</li> <li>Business ethics</li> <li>Customer relationship management</li> <li>Information security management</li> </ul>	<ul style="list-style-type: none"> <li>Energy management</li> <li>Circular economy</li> </ul>	<ul style="list-style-type: none"> <li>Daily communication meetings</li> <li>Cooperative agreement</li> </ul>	<ul style="list-style-type: none"> <li>Sustainability reports</li> <li>Company website</li> </ul>
<b>Government agencies</b> 	<ul style="list-style-type: none"> <li>Environmental management and compliance</li> <li>Air pollutant emissions</li> <li>Climate action</li> </ul>	<ul style="list-style-type: none"> <li>Water resources management</li> <li>Business ethics</li> </ul>	<ul style="list-style-type: none"> <li>Government communication meetings</li> <li>Government inspections and field visits</li> <li>Information disclosure and reporting</li> </ul>	<ul style="list-style-type: none"> <li>Thematic training</li> <li>Regular visits</li> <li>Awards and recognition</li> <li>Sustainability reports</li> <li>Company website</li> </ul>

Stakeholders	Top Concerns		Engagement Channels	
<b>Community representatives</b> 	<ul style="list-style-type: none"> <li>Economic performance</li> <li>Business ethics</li> <li>Occupational health and safety</li> <li>Community relations and cultural communication</li> </ul>	<ul style="list-style-type: none"> <li>Product quality and safety</li> <li>Customer relationship management</li> </ul>	<ul style="list-style-type: none"> <li>Community opinion processing and feedback</li> <li>Community representatives' supervision and engagement</li> <li>Mill visits</li> <li>WeChat communication platform</li> <li>Project cooperation</li> </ul>	<ul style="list-style-type: none"> <li>Charitable activities and volunteer activities</li> <li>Papermaking culture popularization activities</li> <li>Community representatives training and communication</li> </ul>
<b>Industry associations</b> 	<ul style="list-style-type: none"> <li>Product quality and safety</li> <li>Digital and intelligent transformation</li> </ul>	<ul style="list-style-type: none"> <li>Economic performance</li> <li>R&amp;D and innovation</li> <li>Business ethics</li> <li>Circular economy</li> </ul>	<ul style="list-style-type: none"> <li>Industrial exhibitions, seminars, and thematic forums</li> <li>Regular visits</li> <li>Awards and recognition</li> <li>Research and cooperation</li> </ul>	<ul style="list-style-type: none"> <li>Collaborate to develop industry standards</li> <li>Industry publications</li> <li>Sustainability reports</li> </ul>
<b>Professional institutions</b> 	<ul style="list-style-type: none"> <li>Energy management</li> <li>Air pollutant emissions</li> <li>Water resources management</li> </ul>	<ul style="list-style-type: none"> <li>Sustainable forest management</li> <li>Circular economy</li> </ul>	<ul style="list-style-type: none"> <li>Industry-University-Research Cooperation</li> <li>Joint talent cultivation</li> <li>Professional exchange and on-site research activities</li> </ul>	<ul style="list-style-type: none"> <li>Training activities</li> <li>Company website</li> <li>Sustainability reports</li> <li>Biodiversity monitoring</li> </ul>
<b>NGOs</b> 	<ul style="list-style-type: none"> <li>Environmental management and compliance</li> <li>Water resources management</li> <li>Sustainable forest management</li> </ul>	<ul style="list-style-type: none"> <li>Climate action</li> <li>Philanthropy and common prosperity</li> <li>Business ethics</li> </ul>	<ul style="list-style-type: none"> <li>Communication on specific topics</li> <li>Charity projects donation and cooperation</li> <li>Regular visits</li> </ul>	<ul style="list-style-type: none"> <li>Sustainability reports</li> <li>Company website</li> <li>WeChat Official Account</li> </ul>
<b>Media</b> 	<ul style="list-style-type: none"> <li>Circular economy</li> <li>Digital and intelligent transformation</li> <li>Water resources management</li> </ul>	<ul style="list-style-type: none"> <li>Product quality and safety</li> <li>Information security management</li> <li>Risk and compliance management</li> </ul>	<ul style="list-style-type: none"> <li>On-site participation in events</li> <li>Meetings, exhibitions, forums, etc.</li> <li>Company website</li> </ul>	<ul style="list-style-type: none"> <li>WeChat Official Account</li> <li>Executive interviews</li> <li>Cooperation on publicity activities</li> <li>Sustainability reports</li> </ul>

# Materiality Assessment

In 2022, 26 sustainability/ESG issues closely related to APP China were identified based on the Company's development focuses and with reference to the GRI Standards, the SASB Standards for Pulp & Paper Products and Forest Management, latest national and industry policies, and major global ESG rating systems such as the S&P Corporate Sustainability Assessment (CSA). Two new issues were added this year, namely "Circular economy" and "Information security management". The content of some other issues were polished to better align with our operational priorities.

A total of 1,668 valid responses to materiality issue surveys were collected through the issuance of online questionnaires this year. According to the survey results and opinions from internal and external experts, we ranked the issues based on their importance ratings and developed the materiality matrix.

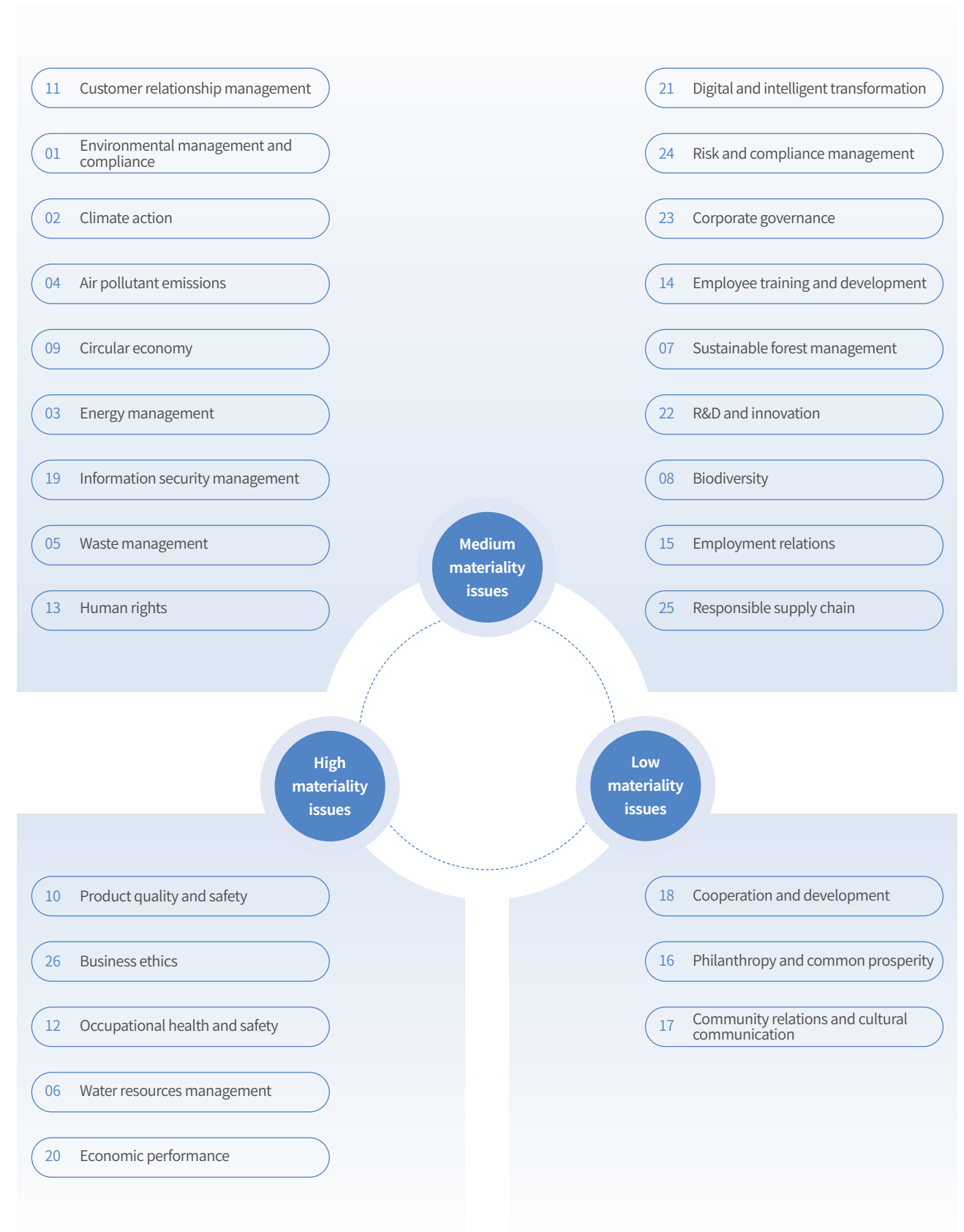
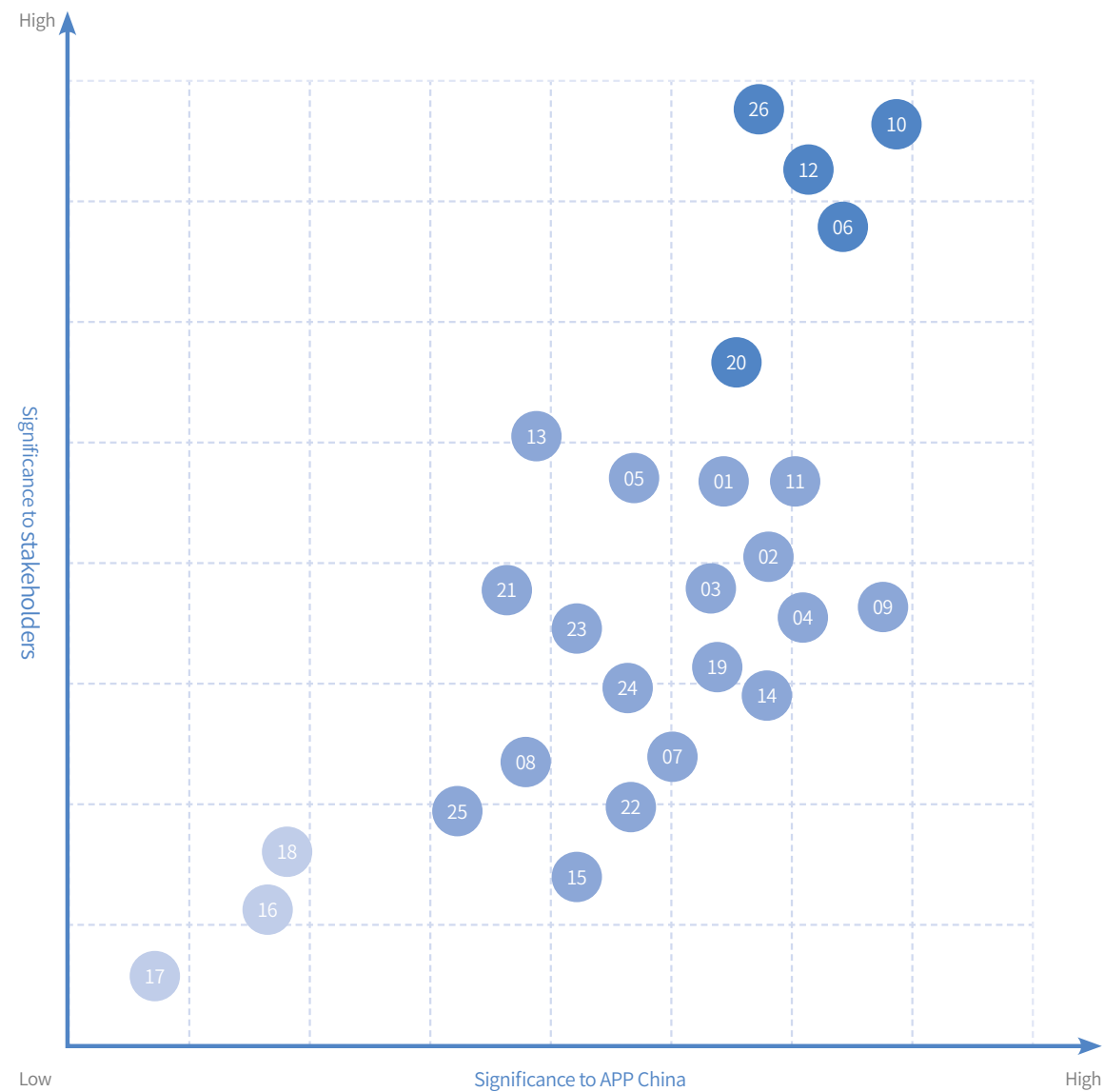



# Annual Focus: Protecting Our Home Planet

In January 2023, the World Economic Forum released its latest *Global Risks Report*. Among the top ten global risks listed in the report, there are five risks related to the ecological environment, including the failure to mitigate and adapt to climate change, natural disasters, loss of biodiversity, and environmental degradation. Without positive actions for change, the accumulation of these risk factors will exacerbate the collapse of the ecosystems on Earth and pose a serious threat to all life on our planet. "Only One Earth" is the campaign slogan of World Environmental Day 2022. These three simple words spell out the warning to human society and the expectations for us to take collective actions.



Practicing Circular Economy and Exploring Innovative Development Models	21
Steadily Promoting Low-carbon Transformation to Address Climate Change	29
Protecting Biodiversity and Promoting Harmony between Humanity and Nature	37

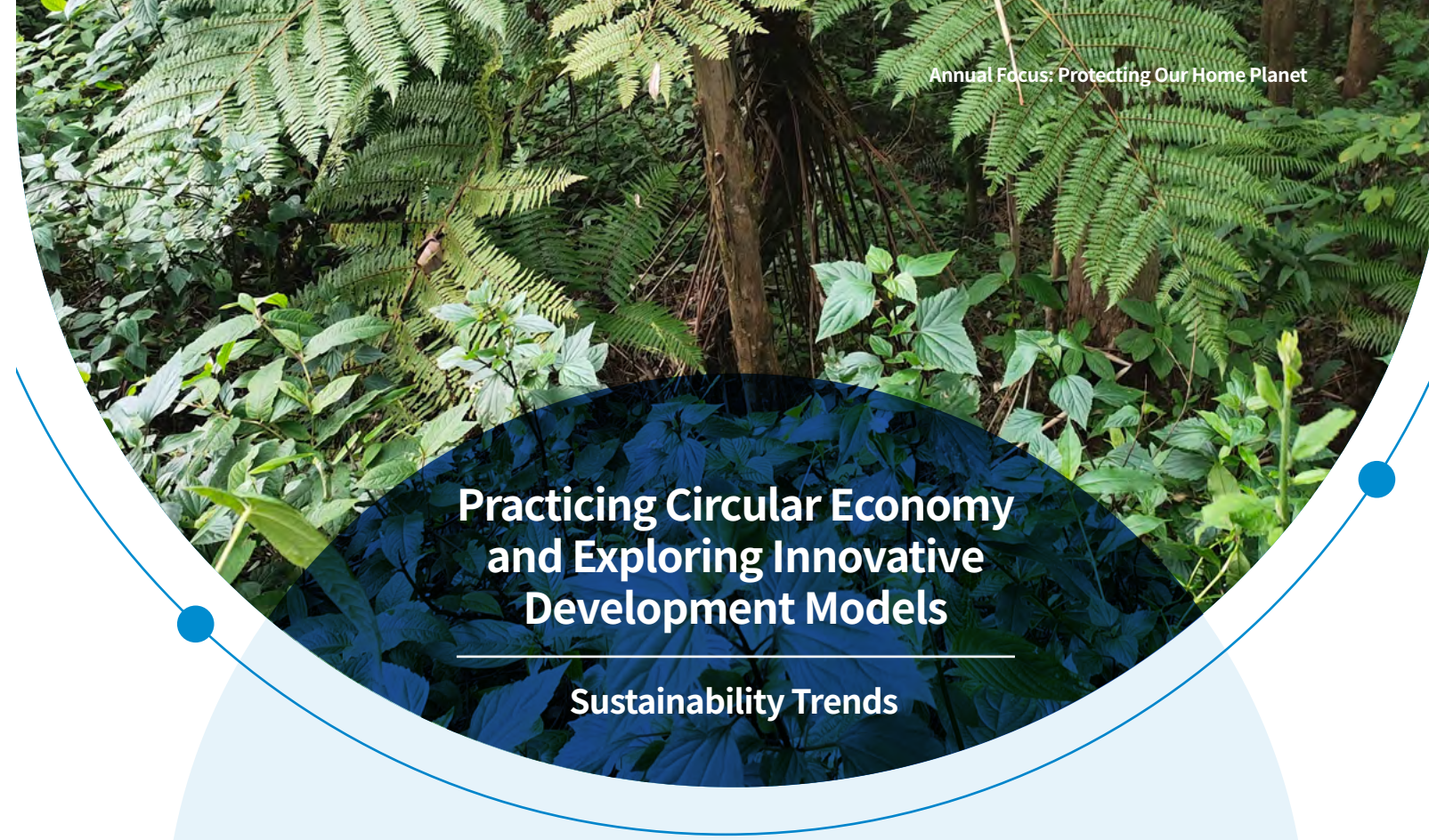

## Practicing Circular Economy and Exploring Innovative Development Models

### Sustainability Trends

Traditional economy, as a one-way economy mainly based on the model of "resources-products-waste", is characterized by low resource utilization rate and high emissions. Compared with traditional economy, circular economy attaches greater importance to the efficient and sustainable use of resources and energy, and helps prevent pollution from the source, playing a positive role in achieving win-win economic and environmental benefits.

China's economy has transitioned from a phase of high-speed growth to a phase of high-quality development. Circular economy is an inevitable choice to accelerate the transformation of economic development mode and achieve high-quality development, and it has become a major strategic initiative for China's economic and social development. The *14th Five-Year Plan for the Development of Circular Economy* (referred to as the "Plan") issued by the National Development and Reform Commission clarifies the goals of circular economy by 2025 and proposes three key tasks: building a resource recycling industrial system and improving resource utilization efficiency; constructing a system for the recycling and utilization of waste materials and building a resource recycling society; and deepening the development of circular economy in agricultural fields and establishing a circular agricultural production mode.

Circular economy is not a new concept for Chinese enterprises. In recent years, the principle of "reduce, reuse, and recycle" has been increasingly integrated into the production stages of a growing number of enterprises, producing numerous exemplary circular economy practices. In the context of the "dual carbon" goal and the "Plan", circular economy has particular importance for enterprises. Enterprises can develop their own circular economy models based on their specific conditions, such as developing green products, reusing resources, and utilizing biomass energy. This approach optimizes the layout and management of the entire industry chain, forms more rational resource flows along the industrial value chain and achieves more synergetic development.

Modern papermaking enterprises have typical characteristics of circular economy in terms of raw material utilization, low carbon emissions, and recycling and reuse. For example, the raw materials for papermaking mainly come from plants, which fix carbon in the form of organic matter through photosynthesis by absorbing carbon dioxide and water. The black liquid, waste residue, sludge and biogas generated in the pulping and papermaking processes can be utilized as biomass energy sources, effectively reducing the dependence on fossil fuels. And waste paper can be recycled in papermaking, reducing the amount of primary fiber materials needed.

In addition, by enhancing their innovation capabilities and promoting industrial optimization and upgrading, papermaking enterprises have immense potential to build a complete circular economy system with low energy consumption, low emissions, and achieve resource and natural carbon cycle, so as to make greater contributions to China's ecological civilization construction.



## APP China's Practices

Adhering to the green circular economy concept of "Integration of Plantation-Pulp-Paper", APP China continues to explore and practice circular economy models along our value chain, constantly achieving new breakthroughs in improving the utilization rate of raw materials, enhancing cleaner production, and developing biodegradable products and biodegradable packaging materials.

### Improving the Utilization Rate of Raw Materials

- Researching on varieties with high pulp yield rate
- Improving the utilization of raw materials
- Reducing the use of raw materials in the product production process

### Promoting Cleaner Production

- Energy-saving upgrading and transformation
- Strengthening renewable energy utilization
- Water resource recycling
- Waste reduction and comprehensive utilization

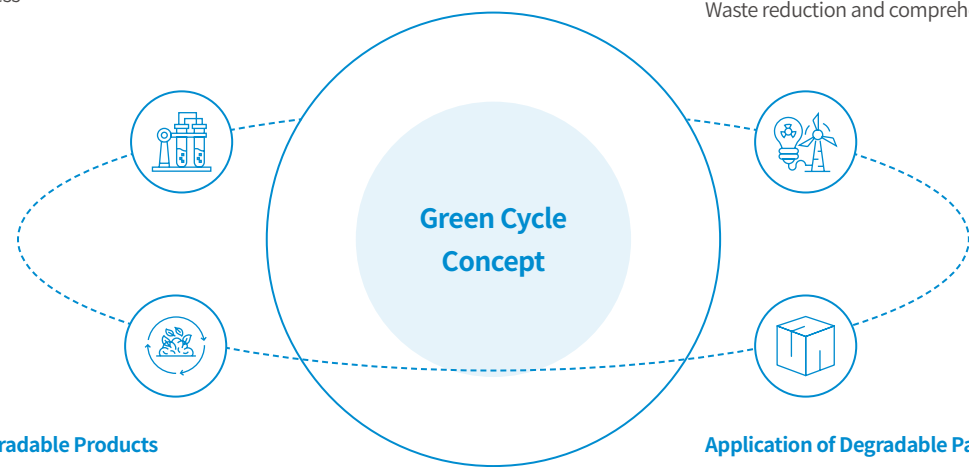

### Developing Degradable Products

- Application of biodegradable new materials
- Research and development of new degradable materials

### Application of Degradable Packaging Materials

- Research and application of degradable packaging materials

### Improving the Utilization Rate of Raw Materials

Wood is a key raw material for pulp and paper enterprises. The efficient use of wood equals better protection of forest resources. APP China actively promotes the effective utilization of raw materials through research of forward-looking technologies and their application, developing lightweight products, and maximizing the ash content of paper.

### Pulp Cooking Project

APP China Forestry and Hainan Jinhai Pulp & Paper have been collaborating in recent years to conduct research related to the pulp cooking performance of different varieties to explore a synergistic way to find better eucalyptus varieties with balanced improvement in both yield and quality. Using wood with a high pulp yield rate can reduce the consumption of forest resources and the use of water, chemicals, and other resources in the production process. It is a beneficial practice for energy saving and emission reduction from the perspective of "Integration of Plantation-Pulp-Paper". In 2022, the project screened out

several high-performing varieties with higher pulp yield rate, higher density, and higher whiteness for growing in greater areas based on comparison of the pulp yield rates by studying and evaluating the pulping performance of wood from different regions, different terrain conditions, and different varieties. In the future, APP China Forestry and Hainan Jinhai Pulp & Paper will continue to carry out this research to support the cultivation and planting of high pulp yield varieties, and continuously promote the conservation and efficient utilization of resources.

### Researching on the Application of Nanocellulose

In 2022, Gold Hongye Paper and China National Pulp and Paper Research Institute established an "industry-university-research" project to study the application of nanocellulose in tissue paper. This study adds nanocellulose modified from the company's broadleaf pulp product back into the paper, which reduces the use of coniferous pulp without adding any additional chemicals while maintaining the product specifications. It not only ensures

the safety and eco-friendly nature of the tissue paper but also champions the sustainable reuse of materials. Tests show that the nanocellulose developed in this project can reduce the use of coniferous pulp in tissue products by 7%. In the future, the project will further optimize the performance of nanocellulose to further reduce the use of coniferous pulp.

### Innovative Study on Making Chemical Pulp and Dissolved Pulp with Small-diameter Wood

APP China has successfully developed pulping technology for making chemical pulp and dissolved pulp with small-diameter wood from Yunnan. Overcoming the traditional concept that small-diameter wood cannot be used for pulping, this project focused on maximizing the use of the smaller-diameter part of the eucalyptus wood from Yunnan, which had great significance

for promoting the efficient use of forests. The quality of the chemical pulp produced by the project exceeds that of Hainan eucalyptus and reaches the quality level close to that of Australian blue eucalyptus; and the quality of the dissolved pulp produced reaches the first-class quality of the national standard.

### Developing Ultra-High Bulk Products

In 2022, Guangxi Jingui Pulp & Paper successfully developed an ultra-high bulk single-sided coated white cardboard based on light weight and high bulk technology, creating another successful case of technologies to reduce the weight of products. Taking the new product with a thickness of 490µm

as an example, which weights 290g/m<sup>2</sup>, 17.1% lighter than traditional single-sided coated white cardboard with the same thickness, which is weighted at 350g/m<sup>2</sup>, resulting in a significant reduction in raw material consumption.

### Promoting Cleaner Production

APP China is dedicated to integrating the concept of circular economy into all major production links, actively carrying out energy-saving transformation, strengthening renewable energy utilization, water resource recycling and reuse, and waste reduction and comprehensive utilization, so as to build a clean, low-carbon, and circular green manufacturing system.

Ningbo Asia, Guangxi Jingui Pulp & Paper, Gold East Paper, Hainan Jinhai Pulp & Paper, and Gold Hongye Hubei mill have been recognized as National Green Factories. Hainan Jinhai Pulp & Paper, Guangxi Jingui Pulp & Paper, and Gold East Paper have been included in the national "2022 Key Water-Using Enterprises and Park Water Efficiency Front-runner" list. Ningbo Asia was included in the list of the first batch of "Zero Waste Factory" in Ningbo in 2022.





### Upgrading the Gas Hood Paper Machine Reducing Gas Consumption to Zero



Hainan Production Base has 16 gas hood paper machines, whose high production capacity also coexisted with the problems of high gas consumption and high greenhouse gas emissions. APP China established a cross-department team of technical experts to comprehensively analyze factors affecting gas consumption, such as equipment and raw materials. They conducted in-depth on-site surveys and precise calculations, developed multiple optimization plans, and ultimately replaced the gas hood with a steam hood and the gas hot air system with a steam hot air system for the overall hood system of the paper machine. They also implemented measures to strengthen energy cascade utilization and recover waste

heat from condensate water. By the end of 2022, three paper machines had been completed, which achieved remarkable results in reducing the unit gas consumption to 0 and the unit comprehensive energy consumption of the paper machines by 20%.

Between October 2021 and August 2022, this pilot project reduced a total of 2,990 tCO<sub>2</sub>e. APP China will replicate this project in China, which is expected to increase its revenue by RMB28 million. In addition, APP China plans to establish a China-Indonesia team to promote this practice in APP's mills in Indonesia.

### Water Resource Recycling and Reuse

#### Hainan Jinhai Pulp & Paper

Increased water reutilization rate of pulping process and paper and paperboard production process to 95.34% and 96.90% respectively through measures such as the reuse of reclaimed water, the reuse of sealing water, and the reuse of condensate water in the pulping process.

#### Guangxi Jingui Pulp & Paper

Increased water reutilization rate of pulp, paper and paperboard production to 94% through measures such as the purification and reuse of net spraying water, the multi-disc grading and reuse of paper machine white water, and equipment upgrades.

#### Gold East Paper

Achieved a water reuse rate of 94.75% for printing and writing paper production through measures such as water-saving upgrading of the paper machine vacuum condenser and the use of ultra-clear white water recycling and reuse technology.

#### Hainan Gold Hongye and Hainan Gold Shengpu

Effectively reduced wastewater discharge by reusing the white water from the extrusion pulping process, reducing its 2022 unit wastewater discharge to 4.75 tons per ton of paper produced, down 33% year-on-year.

### Strengthening the Use of Biomass Fuels



Increasing the use of biomass fuels is an important way for manufacturing enterprises to save energy and reduce carbon emissions. Hainan Jinhai Pulp & Paper and Guangxi Jingui Pulp & Paper have been using alkali recycling technology to evaporate, burn and causticize the black liquor generated in the pulping process to recover heat and caustic soda, and the recovered heat was mainly used for heat generation and power generation. Meanwhile, other mills also take measures to strengthen the efficient recovery and utilization of other biomass fuels, such as bark and wood chips. In 2022, a total of 3,516,670.13 tons of biomass fuels, including black liquor, bark, wood chips, roots, and pulp residue, were used in the mills within the reporting scope, an increase of 10.46% compared to the previous year.

Forestry biomass energy is a major source of biomass energy and an important component of the implementation of the circular agricultural development model in the *14th Five-Year Plan for the Development of Circular Economy*. In 2022, APP China Forestry leveraged its self-owned plantation and

forest resources to develop biomass energy forests in multiple locations, including growing a total of 1,020 *mu* of *Castanopsis fissa* biomass fuel forests in Guangdong and Guangxi. In addition, APP China Forestry invited experts from the Chinese Academy of Forestry's Institute of Fast-growing Trees to visit its plantation in Hainan to conduct field research on biomass collection and processing, and biomass fuel forest planting. The experts also participated in the training conference on biomass energy forests theories and technologies hosted at the same time.

In 2022, APP Forestry Hainan BU launched a biomass supply project. After several rounds of operation process identification and evaluation, and quality inspection and improvement, the biomass fuel produced in Hainan finally meets the specifications and quality standards of the mills. By the end of 2022, APP Forestry Hainan BU had provided a total of 24,751 tons of biomass fuel to the mills operated by APP China, playing a role in helping them increase the utilization ratio of biomass energy.



### Utilization of Non-hazardous Industrial Solid Waste as Resources



Hainan Jinhai Pulp & Paper vigorously promotes the green development mode, actively attempts to utilize solid waste resources, and strives to explore new ways to increase the utilization rate of solid waste as resources. The non-hazardous

solid waste of the company mainly includes ash, furnace bottom slag, desulfurization gypsum, green mud, white mud, sludge, recycled paper fibers, pulp residue, bark, and wood chips.

Ash is generated in the boiler flue gas dust removal process in power generation unit, and bottom slag is the slag discharged from the bottom of the MB boiler in the power generation unit. They are both good building materials and used widely.

Desulfurized gypsum is a by-product obtained from the limestone-gypsum wet desulfurization process in the power generation unit. It can be used for the production of various gypsum boards or as a cement retarder.

Green mud is produced in the digestion section of the causticization unit, and can be added in fuels with cement.

White mud is discharged during emergency repairs in the causticization unit, and has been fully reused through process improvements.

Sludge is generated from various sedimentation tanks in wastewater treatment plants, mainly consisting of fine fibers, microorganisms, humic colloids, and silt. After dewatering, it can be sent to the power generation unit for incineration.

Recycled paper-making fibers are generated by sedimentation of paper-making wastewater in a sewage treatment plant, mainly consisting of fine fibers and silt; pulp residue is produced in the cooking section of the pulping unit, mainly consisting of fiber. They can be used as raw materials for the production of low-end paper products.

Bark and wood chips are generated during the process of log peeling and wood chips screening in the wood preparation unit, mainly consisting of lignin and fibers, and they have high heating value and can be used for incineration in the power generation unit.

### Developing Degradable Products

In recent years, APP China has launched a series of "zero plastic" products, such as "zero plastic" paper cups, "zero plastic" oil-proof food-grade board, antibacterial fresh produce wrapping paper, straw base paper, and lamination-free kraft paper, etc. Products made with these materials, such as paper cups, paper bags, and food boxes, can

be recycled to make paper or disposed with the composting and degradation treatment. While actively developing degradable products, we also strove to promote the scaling-up of degradable technology, promoting its industrial application in the paper industry.

### An Innovative Cellulosic Biomaterial



APP China's Bio-Based Composite (abbreviated as "BBC") product, made its debut at the 2022 CIIIE. As the latest showcase of APP's environmental product development, this environmentally friendly product BBC has 91% bio-based content, 100% compostable and biodegradable compared to ordinary plastic reinforcement products. Its raw materials are extracted from natural materials, and after use, it can be recycled and decomposed by microorganisms to cultivate seedlings for reforestation as humus, ensuring outstanding value of circular economy.

As a hollow fiber, BBC is more easily compatible with various biodegradable plastics with special treatment, giving plastic composite materials greater application possibilities, such as optimizing the physical strength and heat resistance of

automobile materials, biodegradable FIBC bags, and food plates, etc.

BBC has passed a number of international environmental certifications and quality tests. Because it can be used in a variety of industrial and consumer applications, it has a much greater plastic reduction and carbon emission reduction potentials compared with ordinary materials. Taking China's annual production of 800,000 tons of biodegradable plastics in 2021 as an example, adding 10% of BBC can help reduce carbon emissions by approximately 240,000 tons. The widespread use of this material can effectively promote the development of green circular economy in atmosphere, soil, and ocean, and make a positive contribution to help achieve China's "dual carbon" goal.



APP China Launches the BBC Product at the 5th CIIIE



### Breakthroughs in Microfibrillated Cellulose Reinforced Packaging Paper Production Technology



In June 2022, the "R&D and Industrialization of Key Technologies for Microfibrillated Cellulose Reinforced Packaging Paper Production" project of Ningbo Asia, in cooperation with Ningbo Institute of Technology of Zhejiang University and Zhejiang University of Technology, was successfully recognized as a Key R&D Plan and "Flagship" Project in Ningbo in 2022. Microfibrillated cellulose (MFC), mainly derived from plant fibers through mechanical defibrillation, is a cellulose material with one-dimensional nanoscale fibers and excellent biodegradability. MFC can be used as a "green" additive in paper production, with the potential to replace non-degradable

petrochemical additives used, thereby contributing to the low-carbon and environmentally friendly development of the paper industry.

With the three-year project cycle, this project focuses on pulp pretreatment and surface modification technologies suitable for industrial applications, aiming at solving the bottleneck problems of current industrial applications of MFC reinforcement technology in making high-performance packaging paper, and promoting the large-scale application of MFC in the field of packaging paper production lines.

### • Application of Degradable Packaging Materials

As an important part of the paper industry, packaging materials are a key focus area for APP China in exploring the implementation of the circular economy. In 2022, Gold Hongye Paper launched a new degradable packing carton for its VIRJOY zero-carbon tissue, which is made of fully biodegradable materials and printed with green water-based ink to minimize its environmental impact. Meanwhile, Gold Hongye Paper

also focused on the research of fully biodegradable materials as a replacement to the petroleum-based plastic film packaging currently used to make this single-pack tissue product fully degradable. The project has completed laboratory evaluation and partial equipment sampling evaluation, and further product development for commercialization is currently underway.



VIRJOY zero-carbon tissue uses biodegradable packaging

## Steadily Promoting Low-carbon Transformation to Address Climate Change

### Sustainability Trends

Influenced by human activities and natural factors jointly, the world has been experiencing climate change characterized by global warming in the past century. In 2022, extreme weather events occurred frequently around the world, and the impact of climate change once again raised widespread concerns. As emphasized in the Sixth Assessment Report of the United Nations Intergovernmental Panel on Climate Change (IPCC), without timely deep emission reduction measures, global temperature rise will far exceed 1.5° C and catastrophic events will occur more frequently, causing irreversible damages to both human society and the environment of our planet.

Facing the unprecedented challenge, it has become a global consensus to take positive measures to cope with climate change. For China, addressing climate change is not only an important area for the country's participation in global governance, but also a crucial pillar for promoting high-quality economic development and ecological civilization construction. In September 2020, China announced its carbon peaking

and carbon neutrality goals. Since then, the central government has successively issued a number of policies to establish a "1+N" policy system, and a series of energy and climate-related policies have been issued by local governments and at specific industry level, all aiming to promote a well-coordinated and steady-paced low-carbon transformation of both the economy and society.

The low-carbon transformation of the manufacturing industry plays a crucial role in China's goal of achieving carbon neutrality. As one of the first batch of industries included in the national carbon trading system, the papermaking enterprises' progress in responding to the "dual carbon" goals has attracted great attention. Traditional papermaking industry is a major user of resources and energy. However, by developing the "Integration of Plantation-Pulp-Paper" model, promoting clean production, strengthening the recycling and reuse of resources, and developing and utilizing biomass as a substitute for fossil energy, the papermaking industry has tremendous potential for carbon reduction.

In the process of reducing carbon emissions, papermaking enterprises face not only the pressure to accelerate the transformation and upgrading of existing production modes, but also a number of significant opportunities, such as cost reduction brought by exploring the energy-saving and carbon-reducing potentials across the entire value chain, and addressing the market demand for green products through industrial restructuring. In addition, by conforming to the development trends of low-carbon electricity and electrification of energy use, papermaking enterprises can enjoy the benefits brought by the overall low-carbon transformation of society. Papermaking enterprises shall take the initiative to shoulder their own carbon reduction responsibilities and work together with their stakeholders to explore green opportunities to develop a new paradigm of low-carbon transformation for the papermaking industry along the process to support the realization of national "dual carbon" goals.

## APP China's Practices

APP China actively implements the strategic decisions of the government regarding carbon peaking and carbon neutrality, fully integrating green transformation into corporate operations, and undertaking actions to mitigate and adapt to climate change from multiple dimensions.

### • Governance

APP China has established a climate change governance system led directly by the Board of Directors, that has identified green transformation as a key development concept of the Company, and leads and oversees the overall implementation of the Company's green transformation plans. Under the Board of Directors, the Economic Committee of APP China is the highest-level management body responsible for guiding the direction and ensuring the orderly implementation of the green transformation of the Company, including formulating carbon emission reduction targets, planning carbon emission reduction projects, and setting and managing carbon emission reduction indicators.

Under the guidance of the Economic Committee, APP China has carried out a series of important climate action initiatives, such as establishing a Carbon Neutrality Project Executive Committee, launching the "dual carbon" strategic plan, enhancing the utilization of green and clean energy, exploring VCS and CCER forestry carbon

sink projects, and producing carbon neutral products. In 2022, we had basically completed the drafting of our "dual carbon" strategic plan, and formulated our carbon emission reduction targets and carbon emission reduction road map.

With its unique Management by Olympic System (MBOS) that highlights on employee participation, APP China encourages all employees to actively participate and contribute to the continuous optimization of energy-saving and carbon emission reduction performance of the Company through the approach of comparing, learning, catching up, helping, and surpassing. By participating in the MBOS proposal competition, employees explored and formulated a variety of energy-saving and carbon emission reduction improvement plans, and formed various of Skill Development Activity (SDA) to ensure the timely implementation of the improvement plans in production and operations.

### APP China's Governance System for Addressing Climate Change

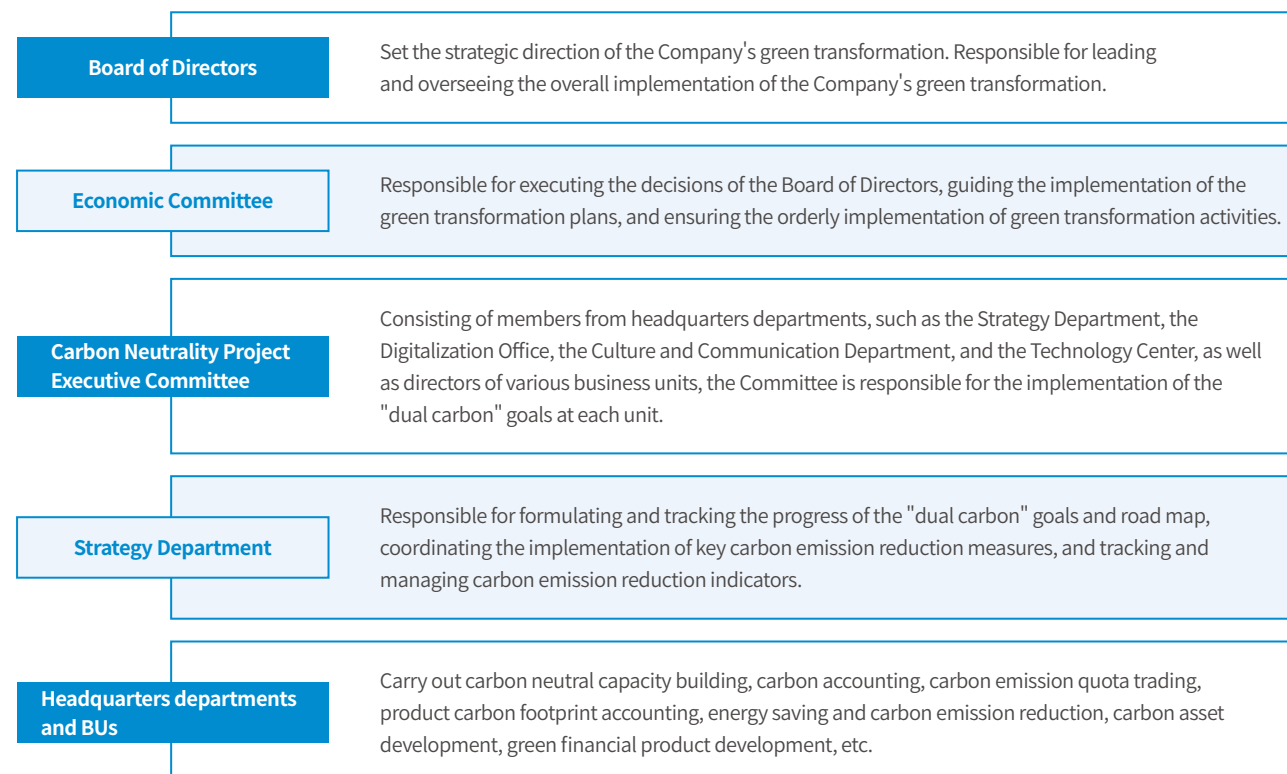

### Hainan Jinhai Pulp & Paper Continuous Tracking Energy-saving Indicators



Applying the MBOS and KPI tracking management approach, Hainan Jinhai Pulp & Paper has broken down energy-saving targets into workshop efficiency KPI targets for management. Specific annual and monthly targets have been set for each level of operations, tracked with the KPI tracking management

system, and checked the progress at weekly meetings. The company tracks the progress to realize the KPI targets and the implementation of improvement plans each month, with the performance data included in the performance evaluation of the departments and the employees involved.

### • Strategic Goals

APP China started drafting its "dual carbon" strategic plan in 2021, with the overall planning almost completed in 2022, setting key carbon management targets with 2021 as the benchmark year. We strive to achieve the carbon neutrality goal through measures such as reducing carbon emissions and intensity, improving energy efficiency, developing and adopting cutting-edge low-carbon technologies, and promoting carbon emission reduction throughout the value chain. The targets have been broken down to our business units, with the specific sub-targets and technical plans still in the process of internal consideration.

#### Targets of APP China Carbon Management:

**Carbon peaking** by 2030 and **carbon neutrality** by 2050

Reduce carbon intensity per unit product by **30%** by 2030

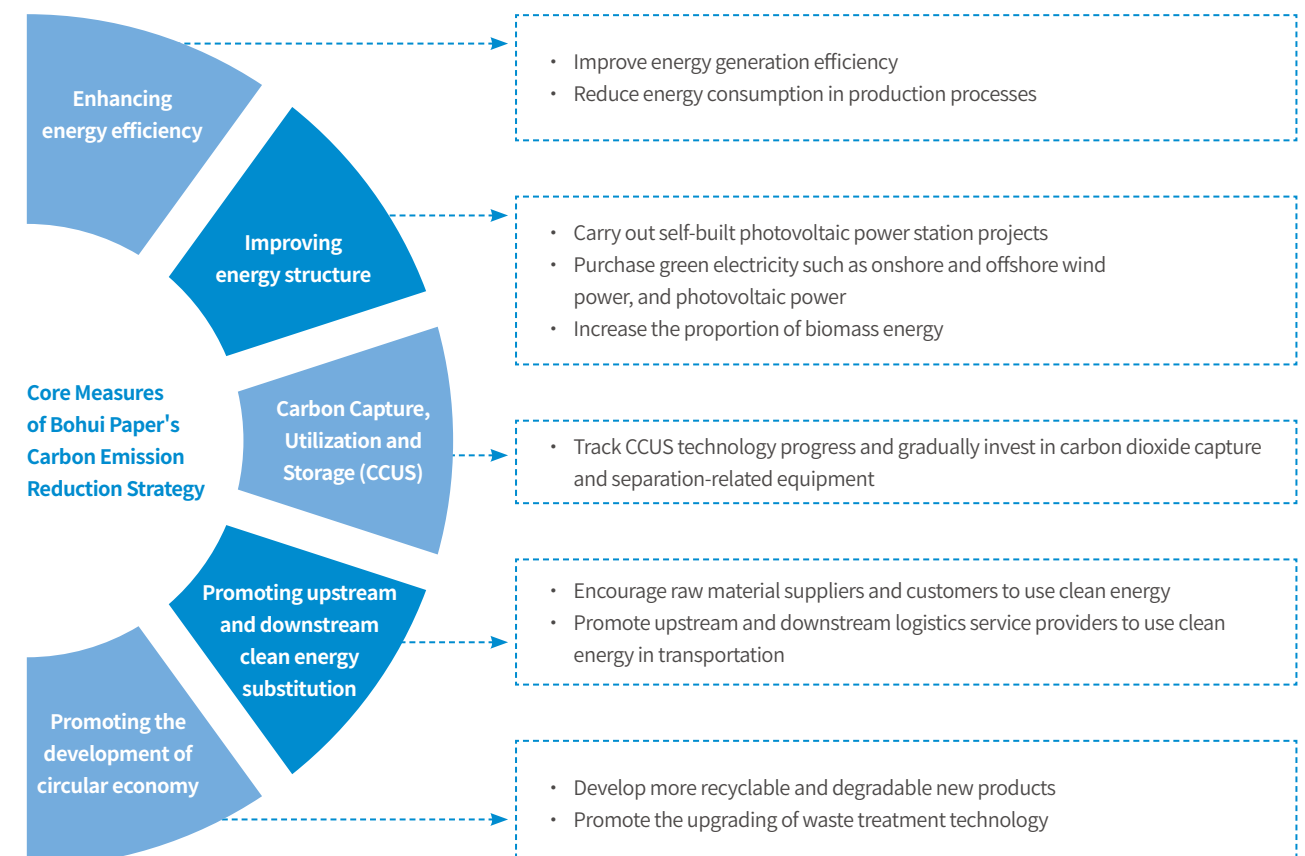



• Climate Risks and Responses



Transition Risks-  
Policy Risks

Risk Factors

- The release of China's "dual carbon" goals has accelerated the pace that carbon emission and carbon intensity to replace energy consumption and energy intensity as the focus of government policies. National and local governments may introduce stricter carbon emission reduction policies and regulations, thereby increasing the Company's compliance operating costs.
- The power plants of APP China's main mills have been included in the national emissions trading systems. It is expected that the paper industry may be included as a whole in the near future. High carbon emissions may increase the operational costs of the Company.

Response Measures

- Each business unit of APP China formulates a detailed policy list every year, against which they conduct compliance inspection regularly and implement relevant improvement measures in a timely manner. When new policies are introduced, all business units will organize relevant thematic training on the new policies to ensure relevant departments fully understand policy requirements, and formulate relevant work plans accordingly.
- The Company actively promotes energy structure transition, implements energy-saving technological upgrades, strengthens the research and application of new technologies, and vigorously promoting the construction of digital and intelligent mills to create synergistic effects of energy saving and carbon emission reduction.
- The Company has enhanced product carbon emission management, set the target of reducing product carbon footprint by 30% by 2030, launched a number of carbon neutral products, and planned to build "zero-carbon mills", to actively address potential emerging regulatory risks in the future.

Risk Factors

- As the government increasingly tightens the control over energy consumption and carbon emissions, the Company's existing technologies and equipment may face the risk of accelerated obsolescence. Either the application of new technologies and equipment or the transformation and upgrading of existing technologies and equipment may increase the Company's operating costs.
- The application of forward-looking technologies such as CCUS is an important way to achieve carbon neutrality, but relevant technologies are not mature yet so there is application risk to certain degrees.

Response Measures

- While introducing advanced low-carbon technologies, the Company continues to strengthen its R&D efforts and actively promote the application of R&D achievements in its mills to effectively reduce the cost of new technology applications.
- The Company actively engages in external cooperation to jointly explore the application of cutting-edge industry technologies. For example, Gold East Paper planned to collaborate with universities to conduct carbon capture research to promote the application of CCUS technology.

Risk Factors

- As consumers become increasingly aware of the green and low-carbon trend, and sustainable consumption, an increasing number of consumers tend to prioritize green and environmentally friendly products regarding their purchases. Meanwhile, market demand for degradable paper products has seen a significant increase due to the introduction of government policies that limit or ban the use of plastic. Therefore, the Company may lose market competitiveness if it fails to develop outstanding green products.

Response Measures

- The Company has successively launched a series of "zero plastic" and "carbon neutral" products, and a number of its industrial, cultural and tissue products have obtained green product-related certifications, such as the China Environmental Labeling Product Certificate. In the future, the Company plans to launch a greater selection of green and low-carbon products.
- Multiple mills of the Company have been recognized as national and local "Green Factories", and the Company's long-term efforts in energy saving and emission reduction have laid a solid foundation for reducing product carbon footprint.



Transition Risks-  
Market Risks



Transition Risks-  
Reputation Risks

Risk Factors

- The manufacturing industry's response to climate change is increasingly attracting the attention of stakeholders, with an increasing number of manufacturing companies at home and abroad have already set their carbon emission reduction goals or net-zero emission goals. If the Company has no positive goals and actions, it may be questioned by stakeholders, which will affect its brand image and reputation.

Response Measures

- The Company has been attaching great importance to green development, and has incorporated green transformation into its core development strategy. It has formulated its own "dual carbon" targets and is taking actively measures to ensure their realization.

Risk Factors

- APP China has plantations in multiple locations in China. Extreme weather events such as typhoons, high temperatures, droughts, and heavy rains caused by climate change pose severe risks and challenges to the Company's forest operations, as well as the employees and other workers' safety and their property security.
- The Company's mills are mainly located in coastal areas, which are prone to risks such as typhoons and floods. Frequent extreme weather events may increase the Company's operating costs and even affect the stability of its operations.

Response Measures

- APP China Forestry has formulated a series of emergency response plans for disasters, such as fires, wind disasters, and diseases and pests, to ensure the timely and effective disposal of the impact of disasters and minimize the loss of forest assets as the result.
- APP China Forestry plants different varieties in different areas based on the geographical location and the characteristics of the environment, such as typhoon-resistant varieties in coastal areas. There are suitable changes for planting techniques according to local climate conditions, such as increasing afforestation planting density and deep planting of trees in typhoon-prone areas, to enhance the wind resistance of the trees.
- The Company's mills maintain close communication with local meteorological services through multiple channels such as WeChat, email, and telephone to ensure access to accurate and real-time alerts. The mills set a robust emergency plan system and enhance the preparedness of emergency facilities and supplies, and establish a dedicated emergency firefighting and rescue team on duty 24/7, to ensure timely disaster relief.
- All plantations and mills purchase relevant insurance coverage every year to reduce potential losses caused by disasters.



Physical Risks-  
Acute Risks

Risk Factors

- In the long run, climate change will lead to more frequent extreme weather events, and the overall temperature increases will also cause systemic ecological impacts, such as increased risk of plant diseases and pests. For paper making enterprises that rely heavily on forests for raw materials, the timber supply capacity of both their own plantations and those of their suppliers will be affected, which may increase their procurement costs for raw materials and even affect the continuity of their production and operations.

Response Measures

- The Company aims to enhance its risk response capabilities from seedling cultivation with intensified investment in the R&D of seedling varieties with characteristics such as wind resistance, waterlogging resistance, cold resistance, disease and pest resistance, and high pulp yield. Meanwhile, the Company is actively exploring ways to increase the yield per acre of its plantations.
- Sustainable forest management improves the climate adaptability of plantations. The Company carries out CFCC/PEFC forest management certification and ISO14001 Environmental Management System certification every year to ensure improve sustainable forest management. In addition, it also keeps increasing the procurement of certified raw materials to promote sustainable forest management along its supply chain.



Physical Risks-  
Chronic Risks

• Exploring Green Opportunities and Innovations

Adhering to the concept of "reducing carbon emissions and increasing carbon sinks", we strive to actively carrying out green innovations from the perspective of the entire industry chain to fully tap the opportunities in the climate-related risks.

Developing Forest Carbon Sinks

In 2022, APP China's plantations continued to grow and totaled an area of 286,000 hectares, an increase of 5.7% compared to the previous year. In 2020, we started performing carbon sink accounting in our plantations, and made the plan to make it an annual task from 2022. According to calculations by a third-party organization, as of the end of 2022, the carbon stock of our plantations reached 44.84 million tons of carbon dioxide, with a net increase in carbon sinks of 2.45 million tons of carbon dioxide.

Meanwhile, APP China is actively exploring and promoting the utilization of the forest carbon sinks of our plantations. In 2022, APP China Forestry launched the Hainan VCS carbon sink project and invited a third-

party organization to conduct inspections in the plantations in Hainan BU. 200,000 mu of forest land has been designated as Hainan Tropical Rainforest National Park in our plantations, of which 70,000 mu is eligible for VCS project development. The project is expected to be completed by 2024.

Guangxi Jingui Pulp & Paper has successfully obtained a RMB50 million as a loan backed by future income from forest carbon sinks. This was the first loan within this category in Guangxi, which showcased the benefits in green finance brought from APP China's forest carbon sinks.



Developing and Promoting Low-carbon Technologies

We have been accelerating the R&D of new energy-saving and carbon emission reduction technologies to promote the efficient utilization of energy and achieve a win-win situation for environmental and economic benefits.

Maglev turbo vacuum pump is a new energy-saving technology that dominates the market with a technological monopoly, which results in high costs of equipment as well as potential technological risks regarding its large-scale applications. APP China set up a special task force regarding

this technology. They conducted research and analysis on the existing technologies of the suppliers, helped them identify application scenarios of the technology in tissue production, and encouraged the suppliers to initiate a series of technological transformation and upgrading projects. Finally, through the use of five new technologies including magnetic bearings, permanent magnet motors, ultra-high frequency converter, cloud-based intelligent monitoring, and dual-motor parallel turbines, this technology was successfully adopted within the Company, leaving

the technological monopoly behind. This technology has been applied in our Hainan mills with an power saving rate of over 60%. If fully applied in our tissue production operations, it was estimated to help the Company save over RMB20 million in electricity cost annually. We have applied this technology to APP's tissue production facilities in Indonesia. Currently, we are researching the opportunities of applying this technology in our cultural paper and industrial paper production operations.

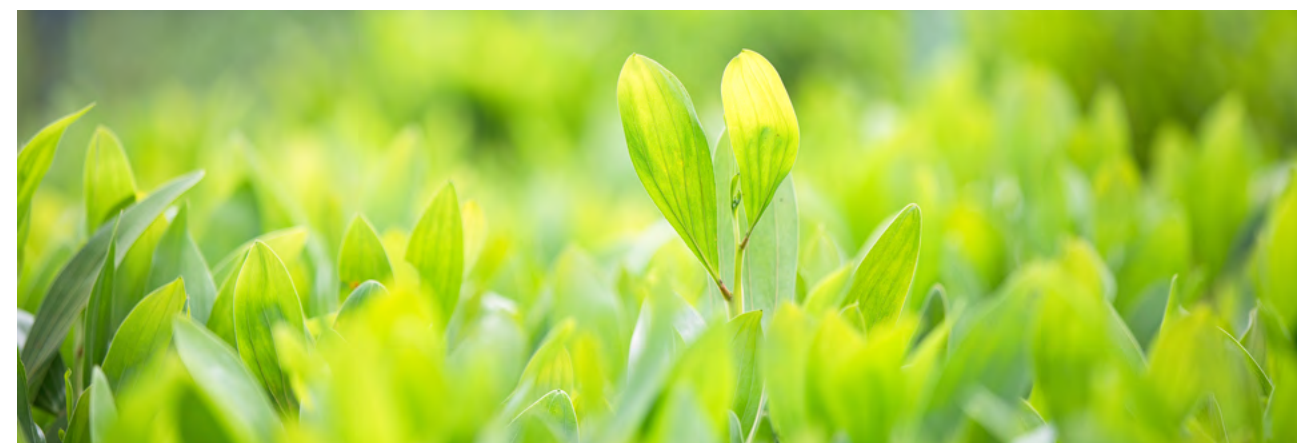

Promoting Green Consumption

We have been intensifying our efforts to develop "carbon neutral" and "zero carbon" products, with a number of household, cultural and industrial paper products obtained carbon neutral product certification. In 2022, APP China launched two new zero carbon tissue products, the Breeze Blossom Zero-carbon Floral Essence

Premium Roll Tissue and the VIRJOY zero-carbon tissue, and the latter was selected as the officially designated tissue product for the 2022 second Carbon Neutral Boao Conference with its carbon neutral certification and its carbon offset of 570 grams of CO<sub>2</sub> each box. It is our hope that by promoting carbon neutral products, the

general public will become increasingly aware of the low carbon and environmental friendly concept. Meanwhile, we have been continuously promoting the CFCC/PEFC forest certification system in China in recent years, urging the public to take actions and promote forest conservation through green consumption behaviors.



APP China's exhibition booth at CIEE

Bohui Paper Passed Carbon Neutral Certification Review

In October 2022, Bohui Paper successfully passed the carbon neutral certification review and obtained the Carbon Neutral Certificate for its white board, cultural paper, and packaging paper products. The company had calculated the carbon dioxide emissions generated during the entire product life cycle, including raw material transportation, production, packaging, product transportation, wastewater discharge, and auxiliary production processes. During the carbon neutral certification on-site review, the reviewers rigorously examined the management of greenhouse gas (GHG) emission sources and emission facilities within the carbon neutrality boundary, GHG emission-related data sources and parameters, and the

verification of carbon emission calculations through a variety of methods, including data sampling, energy consumption data stream access, meeting exchanges, on-site facility inspection, document reviews, and personnel interviews. By offsetting the GHG emissions of the product life cycle in the National Voluntary Emission Reduction Registration System, the company realized carbon neutrality of the relevant products over the life cycle.

As a positive move to promote green products, carbon neutral certification allows Bohui Paper to increase the credibility and transparency of its products with enhanced accuracy and transparency of GHG emission data.



### Promoting Sustainable Consumption by Raising Awareness of China Forest Certification System



From September 26th to October 1st, 2022, the nationwide roadshow "China Forest Certification in Action" co-hosted by APP China, China Forest Certification Council (CFCC), and Programme for the Endorsement of Forest Certification (PEFC) was held in Guangzhou. The event aimed to promote and raise the public awareness of China forest certification system and allow more people learn about forest certification as a reliable reference regarding the sustainability information of paper products for consumers to make their purchase decisions.

At the symposium during the event, experts of the Forest Certification National Innovation Alliance's members, including Guangdong Academy of Forestry, PEFC China Office, and APP

China, etc., provided the audience with a series of well received sharing on promoting high-quality forestry development with forest certification, PEFC and sustainable forest management, and sustainable development of enterprises and forest certification practices. The event also promoted the China forest certification system in campuses, communities, and office buildings in Guangzhou through face-to-face communication, and conducting questionnaire surveys, etc., aiming to offer people tissue-related everyday tips and promote healthy and environmentally friendly ways to use tissue.



"China Forest Certification in Action" nationwide roadshow



## Protecting Biodiversity and Promoting Harmony between Humanity and Nature

### Sustainability Trends

Biodiversity not only provides humans with food, fiber, timber, medicinal and various industrial materials, but also plays an important role in maintaining ecological balance and serves as a crucial foundation for human survival and development. However, with the rapid growth of the population and the intensification of human economic activities, endangered species are increasingly becoming extinct, the area of various ecosystems has plummeted, and the biodiversity is also facing severe threats.

The international community is taking active measures to promote biodiversity conservation. In December 2022, the 15th Conference of the Parties (COP15) (the second phase) to the Convention on Biological Diversity was successfully held in Montreal, Canada. COP15 adopted the landmark "Kunming-Montreal Global Biodiversity Framework" (referred to as the "Framework"). In the future, all signing parties will update their national

biodiversity strategies and action plans in accordance with the Framework, promote the integration of biodiversity into the concerns of governments and businesses, and implement monitoring, verification, assessment, reporting and other measures to promote the implementation of the Framework.

Companies face a series of biodiversity-related risks with increasing concerns from stakeholders regarding the impact of their operations on biodiversity. Biodiversity-related laws and regulations will become stricter in the future, and companies that fail to comply with them will face higher regulatory risks. Most mainstream ESG ratings at home and abroad are increasingly considering companies' efforts in biodiversity conservation, and companies that do not prioritize biodiversity issues may lose investor support. Furthermore, environmental organizations, media, consumers, and the general public

are also increasingly concerned about environmental issues, including biodiversity, and companies that lack biodiversity impact management actions will face significant reputation risks. In fact, the loss of biodiversity and deterioration of the ecosystem will directly affect the business activities of enterprises, bringing risks such as increased costs and disruption of operations.

There are close interconnections between many environmental topics. For example, by strengthening biodiversity conservation, the number and area of wildlife habitats will increase, which also plays a positive role in promoting the realization of "net zero" emissions of greenhouse gas. Therefore, to avoid relevant risks and ensure continued competitiveness in the future, it is necessary for companies to attach importance to biodiversity, take positive measures to manage the impact of their operations on biodiversity, and protect biodiversity.



## APP China's Practices

APP China regards "insisting on integrating sustainable development of forest resources and biodiversity conservation, high conservation value areas protection, and ecological protection into social and economic development" as one of the key principles of forest management, and has included "protecting biodiversity and soil and water resources, apply full-process control of business activities, and maintain regional ecological stability" in the *APP China Forestry Vision, Mission and Policy*. The Company strictly complies with national laws and regulations such as the

*Forest Law, the Wildlife Protection Law, and the Regulations on Wild Plants Protection*, and has formulated relevant policies and regulations, such as the *Afforestation Operation Standard, the Wildlife (RTE Species<sup>1</sup> Included) Protection Regulations, and the Measures for the Administration of Biodiversity Conservation and Monitoring* to normalize the implementation of biodiversity conservation.

Regarding raw material procurement, we have formulated a series of relevant requirements and regulations for suppliers,

such as guaranteeing that all wood chips come from plantation forests, adopting appropriate forest management activities to protect high conservation value (HCV) forests in source forests of timber, and forbidding the use of waste and wood residues that are not on the list of the International Union for Conservation of Nature (IUCN) and the Convention on International Trade in Endangered Species of Wild Fauna and Flora (CITES) Appendix I.

<sup>1</sup>RTE Species: A collective term for rare, threatened, and endangered species.

### • Biodiversity Monitoring and Conservation

All forest farms of APP China Forestry continuously carry out forest HCV monitoring in accordance with the company's management systems such as the *High Conservation Value Identification and Management Procedures and the Identification and Protection of Traditional Rights and High Conservation Value 4-6*. Species diversity is one of the six types of HCV. If rare, threatened or endangered wildlife species are found in monitoring, our staff will take actions to protect and manage in accordance with relevant HCV management requirements.

Local governments where our plantations are located are increasingly attaching importance to biodiversity conservation. For example, there were government-initiated conservation awareness-raising

campaigns in the Naban River Reserve in Xishuangbanna for the protection of Indian bison, and in Lancang County for Asian elephants, both located in Yunnan; and for wild plants in Jiangxi Province. The company actively responded to local government initiatives, participated in these conservation awareness-raising campaigns, and is ready for greater involvement in more conservation activities. In our Lancang plantations in Yunnan, part of eucalyptus plantations overlap with natural woodlands, and we have identified that there are Indian bison living in the forest. To better protect them, we stopped using pesticides and chemicals for weeding in adjacent eucalyptus forest, left more vegetation for them to graze by using manual weeding in forest with trees younger than three years, and stopped weeding afterwards.

In the monitoring in 2022, there were herds of Indian bison and Asian elephants sighted passing through Lancang Huimin plantations in June and October, respectively. In December 2021, we identified the national second-class protected plant, *Alsophila spinulosa*, in Lancang BU, and set up protective signs and buffer zones around the trees. In 2022, we continued to monitor and protect the *Alsophila spinulosa*, designating a

100-hectare area of plantations around the trees as habitat for rare species to protect them from human disturbance or damage.

In 2022, Hainan Jinhua Forestry Co., Ltd. carried out regularly monitoring activities during the reporting year adhering to the principle of "protecting biodiversity and maintaining ecosystem stability". The company set a target of controlling the

fire hazard rate within 0.2‰, and strove to prevent fire hazards and minimize the possible damage to the ecosystem caused by fire through measures such as enhancing the construction of firebreaks and conducting inter-tillage weeding. Through these efforts, there was no incident of fire during the year in all six major forest farms in Hainan.

### Participating in Asian Elephant Protection



After receiving the report that Asian elephants were witnessed in the plantation, Lancang Huimin forest farm immediately participated in the protection activities of the local government.

Joined the local "Asian elephant alert group" to stay informed, actively cooperated with local forestry administration in awareness raising and protection activities, and strengthened training and awareness raising in operations, such as strictly prohibiting harming or killing of Asian elephants and paying attention to safety precautions.

Sent Asian elephant monitoring personnel to participate in the training on information management of Asian elephant monitoring organized by local government to improve relevant skills.

#### Participating in Asian Elephant Protection

Carried out public safety and wildlife protection awareness-raising activities in villages along the route of the herd promptly.

Cooperated with government agencies and arranged personnel to be on duty on holidays to monitor the Asian elephants along their route to help prevent major safety accidents or injuries to the animals.

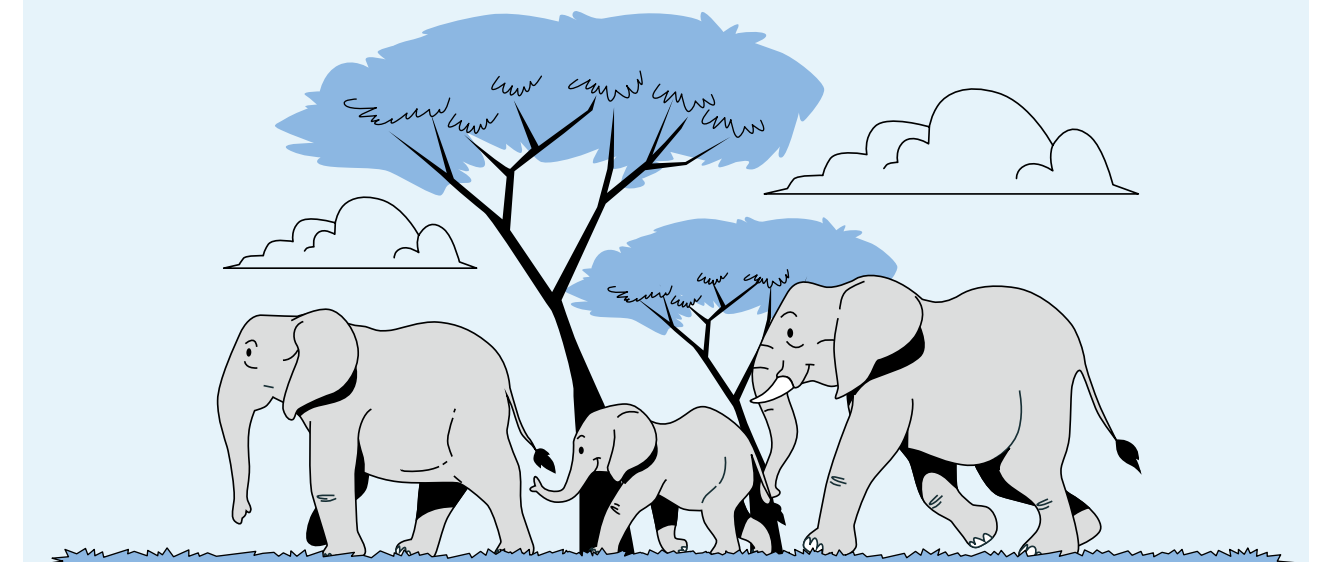

Lush vegetation in Lancang plantations



## APP China Forestry's Key Biodiversity Conservation Measures

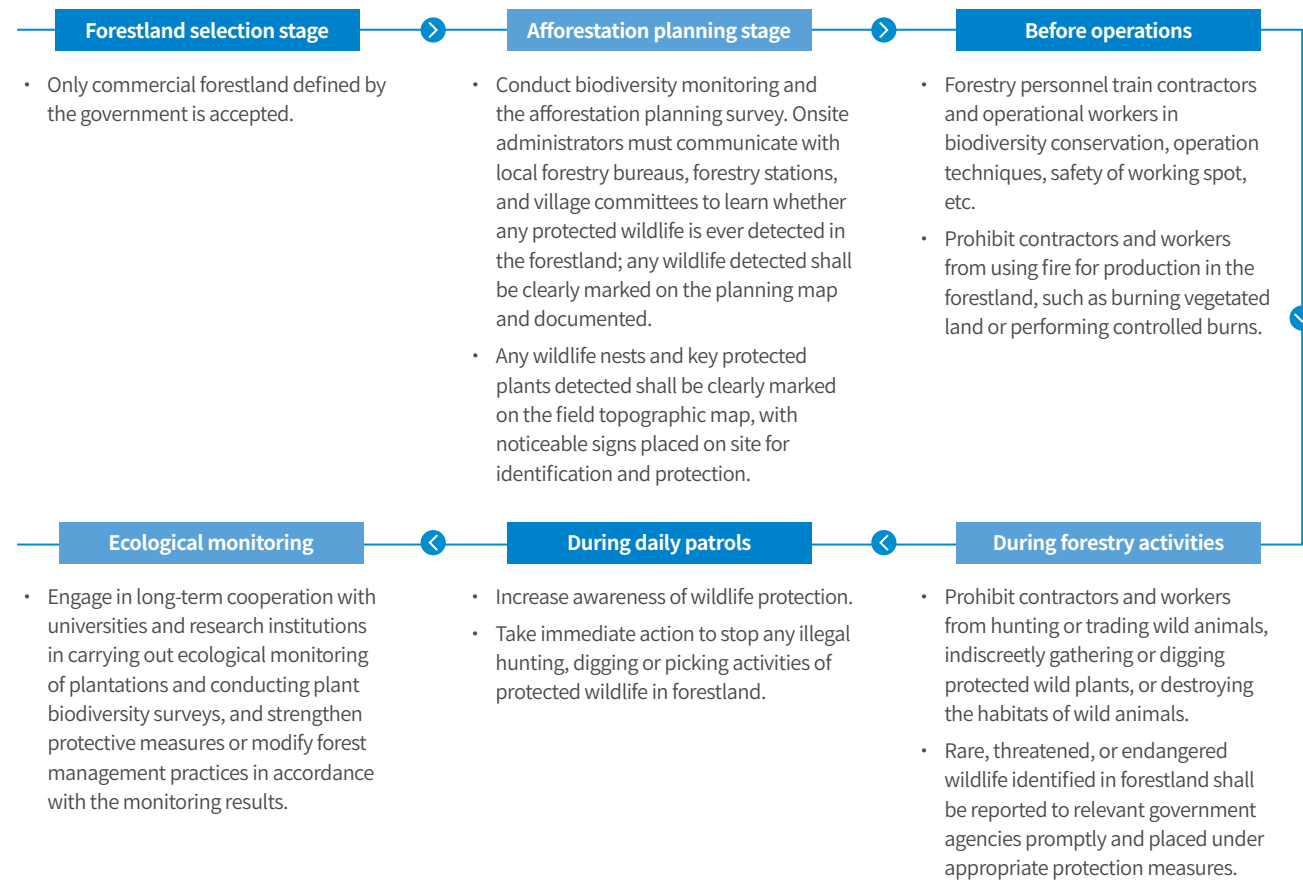

### Biodiversity Impact Monitoring and Assessment

APP China Forestry has long-term cooperation with universities and research institutions to monitor and track the impact of forest management activities on ecosystems and biodiversity. In 2022, the Company cooperated with the Institute of Ecological Industry of Guangxi Academy of Sciences and the School of Forestry of Hainan University to carry out plantation ecological monitoring projects in the fields of plant diversity, forest growth, soil fertility, runoff field water quality, and water and soil erosion, and cooperated with the School of Earth Sciences of Yunnan University and Guangdong Eco-Engineering Polytechnic to conduct a special monitoring project on plant diversity, recording and calculating the understory plant species richness



Eucalyptus trees in an APP China plantation

in eucalyptus plantations to analyze the impact of eucalyptus plantations on plant diversity. By conducting these monitoring projects, the Company strove to find a scientific, quantitative, and objective method to evaluate the ecological values of eucalyptus plantations, aiming to reduce the negative impacts and ecological costs in the management of eucalyptus plantations. By looking for improvement opportunities in the monitoring of ecological impact and plant diversity impact during the monitoring process, the Company continued to optimize the monitoring contents to provide a more scientific basis for the healthy and sustainable development of eucalyptus plantations.

### Monitoring Plant Biodiversity

In 2022, APP China Forestry Guangdong BU collaborated with Guangdong Eco-Engineering Polytechnic to carry out a eucalyptus plantation biodiversity monitoring project in Qingyuan, Heyuan, Yangjiang, and Shaoguan. The project team designated sample plots of macrophanerophytes, shrubs and herbs at each survey site, recorded data from each plot and calculated the indicators such as the density, dominance and frequency of macrophanerophytes, and the frequency, coverage, and importance value of shrubs and herbs based on the recorded data. Through the analysis of the survey data, it was concluded that the biodiversity conditions in eucalyptus plantations is relatively high, the biodiversity indicators showed a rapid upward trend compared with the previous year, and it does not appear that eucalyptus plantations have significant impact on the biodiversity of undergrowth shrubs and herbs. The project team also compiled a catalogue of shrubs and herbs found in eucalyptus plantations in Guangdong, which would be continuously monitored during the subsequent year to ensure an objective and sound assessment of the biodiversity of eucalyptus plantations.

In November 2022, APP China Forestry initiated a biodiversity survey project in Lancang in collaboration with the School of Earth Sciences of Yunnan University. The survey mainly focused on three types of forest land, including APP China eucalyptus plantations, *Pinus kesiya Royle ex Gordon* plantations grown by local communities, and natural forests. The survey team conducted comprehensive identification, measurement, and recording of plants in the entire sample area. The main flora includes plants from the fagaceae family, such as *Pinus kesiya Royle ex Gordon*, *Castanopsis fleuryi* Hickel & A. Camus, *Craibiodendron yunnanense* W. W. Smith, Hongmuhe, etc., as well as wild protected plants such as *Litsea pungens* Hemsl. and *Archidendron clypearia* (Jack) I. C. Nielsen, etc.



Biodiversity survey site of APP China Forestry and the School of Earth Sciences of Yunnan University

### Biodiversity Training

APP China Forestry organizes biodiversity training for various functional departments and forestry staff at irregular intervals. The training mainly covers the requirements of biodiversity-related laws and regulations, the methods to identify key wildlife, survey and monitoring methodologies, and protection strategies and measures. At each plantation, forestry personnel post pictures

of protected wildlife and bulletin boards of environmental protection and safety tips, provide on-site training, and give an awareness-raising talk to the workers before they started working every day. In 2022, Lancang BU invited experts from Yunnan University to conduct training on plant diversity for its employees.

### Organizing Thematic Training on Biodiversity

In September 2022, APP China Forestry Guangxi BU conducted a thematic training on biodiversity for all employees through a combination of online and offline ways. During the training, employees studied the requirements of international conventions and relevant national laws and regulations such as the *Convention on International Trade in Endangered Species of Wild Fauna and Flora (CITES) Appendix I, II, and III*, the *China's Red List of Biodiversity: Higher Plants*, and the *China's Red List of Biodiversity: Vertebrates*, and familiarized themselves with the catalogues of key protected animals and plants in different regions in Guangxi to improve their biodiversity identification capability.

During the training, the company also introduced the specific requirements for biodiversity survey, and provided detailed information on the identification and protection methods for HCV wildlife, as well as biodiversity conservation measures in forestry operations.

The training strengthened employees' awareness of biodiversity conservation and provided effective guidance to forestry personnel on operational compliance and biodiversity conservation in plantations.



# Environmental:

## Creating a Picture of Green Development

Sustainable Forest Management	44
Managing Environmental Footprint of Operations	48

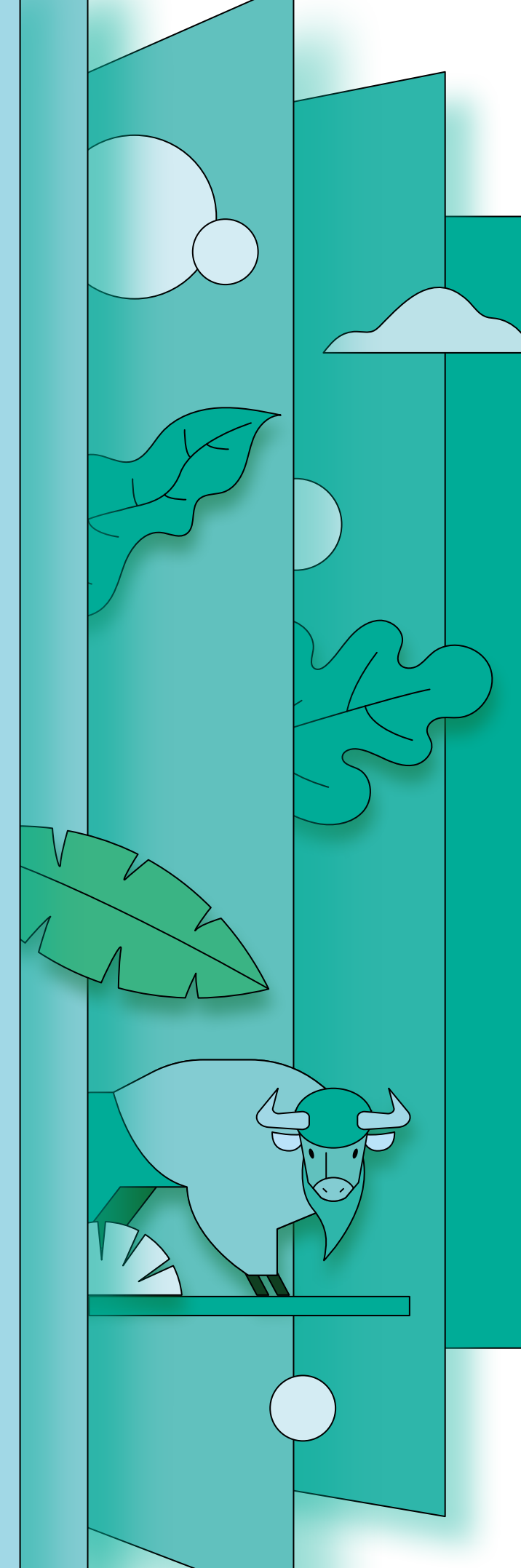



## Sustainable Forest Management

### Our Commitment

Adhering to our forestry management concepts focusing on "compliance, technology, ecology, harmony, and sustainability", we strive to achieve win-win economic, social, and ecological benefits through sustainable management of plantations.

### Our Progress:

**24** forestry companies, increased by **2** compared to 2021

**286,342.76** hectares of plantations, up **5.7%** year-on-year

**19.2251** million seedlings cultivated in 2022, up **20.75%** year-on-year

**44.84** million tons of CO<sub>2</sub> fixed in plantations, with a net increase of **2.45** million tons of CO<sub>2</sub> in forest carbon sinks

**245,246.28** hectares of plantations are CFCC/PEFC-FM-certified, accounting for **85.65%**

**100%** of raw wood materials supplied by our plantations to our pulp mills are CFCC/PEFC-FM-certified

**61%** of our plantations are ISO 14001-certified

**51%** of our plantations are High Conservation Value-assessed

## Sustainable Forest Audit

APP China Forestry carries out the certification work of CFCC/PEFC-FM forest certification and ISO14001 Environmental Management System certification every year, using both internal and external audits to identify projects that do not meet the certification standards for rectification, to ensure the continuous improvement of sustainable forest management and a green and sustainable source of the industrial chain. In 2022, 12 APP China Forestry companies received CFCC/PEFC-FM certification audits, three new companies initiated their certification process, and six completed the re-certification audits for ISO14001 certification.

The *Forest Certification in China - Forest Management* (GB/T 28951-2021) came into effect on December 1, 2021, and 2022 was the first year that audits were carried out in accordance with the new standard. The Sustainability Department of APP China Forestry organized employee to deeply study the new standard and its interpretation in early 2022, and conducted internal audits of all aspects of their forest management operations in accordance with the new standard to identify and rectify any deficiencies.

From April to July 2022, APP China Forestry carried out its CFCC/PEFC third-party

audit. Third-party audit organizations were brought in to conduct comprehensive review and assessment of the Company's forest management system and forest management activities in accordance with the newly effective *Forest Certification in China - Forest Management* (GB/T 28951-2021) standard, covering a wide range of aspects such as the implementation of laws and regulations, forest land ownership and disputes, the protection of the rights and interests of employees and workers, the implementation of forest management programs, the cultivation and utilization of forest resources, biodiversity conservation, environmental impact and assessment,

forest protection, etc. In addition, in response to the evaluation requirements on internal audit and management review that added to the new standard, expert auditors audited the review and rectification activities APP China forestry conducted, covering its annual internal audit, rectification of management review in 2021, and current management status. The rigorous and thorough audit did not find any major non-compliance issue, and all plantations had completed the rectification for the observation items and minor issues identified by the auditors.



APP China Forestry conducted its annual CFCC/PEFC third party audit

## Forestry Risk Management

We have formulated and been continuously improving emergency response procedures for disasters, specifying the response measures for the various types of disasters, such as the *Disaster Emergency Response Procedures*, the *Lightning Disaster Response Plan*, the *Typhoon Disaster Emergency Response Plan*, the *Eucalyptus Frozen Disaster Emergency Response Plan*, specifying the response measures and procedures for fire, strong wind, flood,

freezing, and diseases and pests, aiming to ensure effective prevention and post-disaster relief and minimize the loss of forest assets.

With our robust disaster response measures, the overall disaster losses of the Company's plantations were under effective control in 2022. During the reporting year, there was 9,114 *mu* of our plantations affected by fire, down

54% year-on-year; 103,982 *mu* affected by natural disasters, down 33% year-on-year. Among the area affected by natural disasters, there was 66,299 *mu* damaged from freezing, down 41% year-on-year; 36,041 *mu* affected by typhoons, down 19% year-on-year; and 1,642 *mu* suffered losses caused by floods and droughts, up 100% year-on-year. The incidence rate of diseases and pests was controlled at 0.61%, which was within an acceptable range.





Risk Management Measures of APP China Forestry

Forest fire prevention

- Formulated the *Forest Fire Prevention Operation Manual* to regulate the Company's forest fire prevention activities and ensure the effective prevention and extinguishing of forest fires in accordance with the fire prevention policy of "focusing on prevention and ensuring active fire extinguishing efforts".
- Worked closely with local governments to advocate fire safety awareness in villages around our forest areas and established an effective fire control mechanism with the villages characterized by supervision by the government, prevention by the company, and active participation of community members.
- Established a forest fire command center at each forest area to take charge of the emergency response operations regarding the prevention and extinguishing of forest fires, and formulate forest fire emergency plans for each management level. Set up a fire command center at each forest farm.
- Organized forest fire safety education sessions and fire drills at regular intervals to continuously strengthen employees' fire safety awareness and preparedness for forest fires, to ensure that employees master the forest fire emergency response methods.
- Built proper fire lines: cut 2- to 3-meter-wide fire lines in large contiguous forest areas and forest areas near farmland, dry land, villages, temples and other areas of greater fire risk to create a combustible-free space.
- Required contractors to abide by the Company's *Safety Production and Environmental Protection Regulations*, which prohibits the use of fire for production purposes in forest areas, such as burning vegetated land or performing controlled burns.
- Purchased forest insurance.

Frost protection

- Strengthened research and experiment on frost-resistant varieties of trees.
- Established a frost monitoring and early warning system, followed weather forecasts, and strengthened communication with local meteorological bureaus to ensure timely response to frost damage.
- Improved the trees' resilience against frost by checking and strengthening the stabilization of the roots in soil, conducting proper pruning, applying antifreeze and anti-frost controls to the soil, wrapping trees with burlap, increasing nurturing and fertilizing, etc., after receiving weather alerts.
- Purchased forest insurance.

Wind damage response

- Strengthened research and experiment on wind-resistant varieties of trees.
- Avoided planting during typhoon seasons to ensure the survival rate of sprout forests.
- Enhanced the forests' wind resistance by increasing plant density and implementing deep planting in affected areas.
- Pruned in advance upon early warnings of incoming typhoons to mitigate wind damage, and activated response plans right after to implement relief efforts within the first 72 hours.
- Purchased forest insurance.

Disease and pest control

- Strengthened the cultivation of high-quality seedling strains resistant to diseases and pests.
- Strictly implemented planting and protection techniques and forest monitoring to ensure scientific, effective, and targeted control.
- Regulated the ecological environment to create an environment conducive to the survival of plants and predators of pests to prevent diseases and pests.
- Maintained hybrid strains and tree species.
- Developed a monthly disease and pest control calendar to enable early prevention and mitigation at the front lines.
- Used drones to spray pesticides.
- Purchased forest insurance.

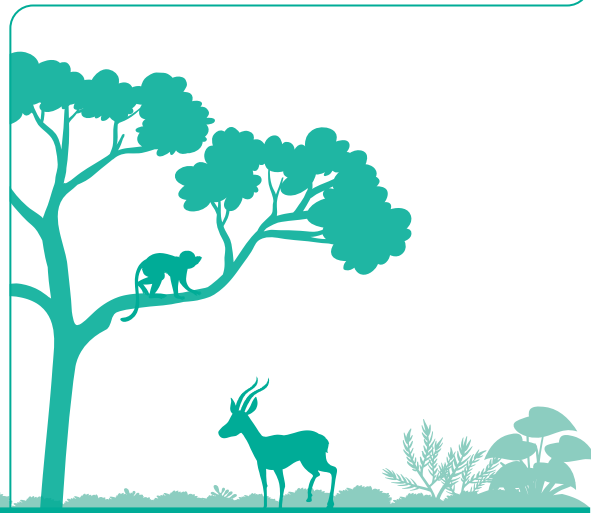

High Conservation Value Monitoring

APP China attaches great importance to the protection of High Conservation Value (HCV) areas and takes active measures to maintain and enhance their conservation value. The value of HCV forests mainly lies in six areas, namely biodiversity, landscape-level ecosystems and ecosystem mosaics, ecosystems and habitats, basic ecosystem services, necessities of local communities, and cultural significance.

APP China Forestry monitors the HCV conditions in our plantations on a quarterly basis to ensure timely conservation of the HCV of forest land. In fact, the identification and protection of HCV are integrated into

the Company's daily forestry operations. Forestry personnel needs to work together with local community representatives to survey and identify HCV at the operation site and its surroundings, and make clear markings on the identified HCV to ensure that it is not affected during forestry operations. Our forest farms maintain smooth communication with local communities and conducted awareness raising and training activities regarding HCV conservation.

In 2022, 51% of our plantations completed HCV assessments. During the Q4 HCV monitoring, a herd of wild elephants

were sighted in the forest land of Lancang Huimin Forest Farm. The Company joined the local "Asian Elephant Alert Group" to stay informed, actively cooperated with local forestry administration in protection activities, and strengthened training and awareness raising in operations, aiming to both protect wild elephants from injuries and prevent property losses to local communities. All our forest areas will carry out regular monitoring and protection of rare wildlife subsequently.





# Managing Environmental Footprint of Operations

## Our Commitment:

Adhere to the original intention of "green papermaking", continuously strengthen environmental impact and risk management, comprehensively promote clean production, accelerate the transformation of energy structure, and actively build green mills by continuous optimizing our environmental performance.

## Our Progress:

- 5 mills awarded National "Green Factory" Average industrial water reuse rate: **95%**
- RMB**1.0117** billion in environmental investment Comprehensive utilization rate of non-hazardous solid waste: **99.37%**
- Solar power generation: **31.0242** million kWh
- Proportion of renewable energy: **25.63%**

## Environmental Management Mechanism

APP China mills strictly abide by laws and regulations such as the *Environmental Protection Law of the People's Republic of China*, and have all established and continued to enhance the environmental management system based on the ISO 14001:2015 standard. Our mills ensure the effective operation of the environmental management system with the establishment of dedicated EHS departments, formulation of environmental management manuals that specify the responsibilities and authorities of each department. Our mills also organize environmental protection law-related training and environmental protection education activities regularly to enhance employees' understanding of the environmental system and relevant environmental protection standards. In 2022, there was no incident of major environmental accidents at APP China.

Our mills carried out environmental risk identification and assessment regarding their own production and operations, established and implemented environmental factor evaluation and control procedures, identified the relevant environmental risk factors in production management activities, products, and services, and evaluated their environmental impact. Timely rectification of key environmental factors had been implemented to control and mitigate the negative impact of harmful environmental factors. Rudong Base reviewed its environmental factors based on the characteristics of the processes of each department, assessing whether they should be categorized as key environmental factors by evaluating factors such as their frequency of occurrence, scope of impact, degree of control management, degree of impact, and

recoverability, etc. Based on the summary analysis on the environmental factor surveys and assessment forms from its departments, Rudong Base developed its own list of key environmental factors, with a total of 17 key environmental factors identified in 2022.

Regarding the wastewater, exhaust gas, waste, and noise from production, our mills have formulated relevant control procedures and regularly carried out environmental monitoring to ensure compliance with relevant discharge and emission standards. Hainan Jinhai Pulp & Paper upgraded its pollution source monitoring system from both hardware and software aspects. In hardware aspect, the company purchased new pollution source online monitoring equipment, and upgraded 2G mobile sim cards with 4G IoT ones; in software aspect, the company adopted the latest pollution

source online monitoring system, and organized training for personnel in charge to ensure the effective operation of the new monitoring system.

Our mills have formulated their own emergency plans for sudden environmental incidents in accordance with the *Technical Specifications for Emergency Monitoring in Environmental Accidents* (HJ589-2021) issued by the Ministry of Ecology and Environment, specifying the prevention, early warning, emergency handling procedures, and response measures for sudden environmental incidents, aiming to ensure environmental safety with a scientific and effective emergency mechanism. Our mills regularly conduct environmental emergency drills, which has been included in their monthly SHE (safety, health and environmental) assessment. Hainan Jinhai Pulp & Paper and Guangxi Jingui Pulp & Paper have established an environmental risk early warning system. When an emission indicator reaches the set limit (lower than national emission standards), relevant personnel will be notified immediately via mobile messaging, prompting them to predict environmental protection abnormalities to reduce the possibility of environmental protection accidents.

## Rudong Base Conducted Environmental Management System Review



In January 2022, Rudong Base integrated the company's environmental and safety management systems together, and released its *Environmental/Occupational Health and Safety Management Manual* in February for implementation. In June, Rudong Base conducted an internal review of its ISO14001 Environmental Management System focusing on factors such as continuity, applicability, adequacy, and effectiveness to evaluation the implementation of the system.

Rudong Base reviewed the operation of its environmental management system in various departments such as of Environmental and Safety, Quality Assurance, and Water and Environment, the progress towards achieving its 2022 targets, the collection and implementation of relevant laws and regulations, and environmental protection awareness and skills training. The review identified two general non-compliance issues and put forward suggestions and requirements for their rectification, which had already been completed by relevant departments. In addition, various departments of Rudong Base also conducted a summary report analyzing the performance of relevant environmental and safety management systems of each department.



## Energy and GHG Management

APP China continuously adjusts and optimizes its energy structure, eliminates outdated production capacity, accelerates the construction of green, low-carbon, and energy-saving projects, aiming to save energy, reduce carbon emissions, and increase efficiency through more efficient use of energy.

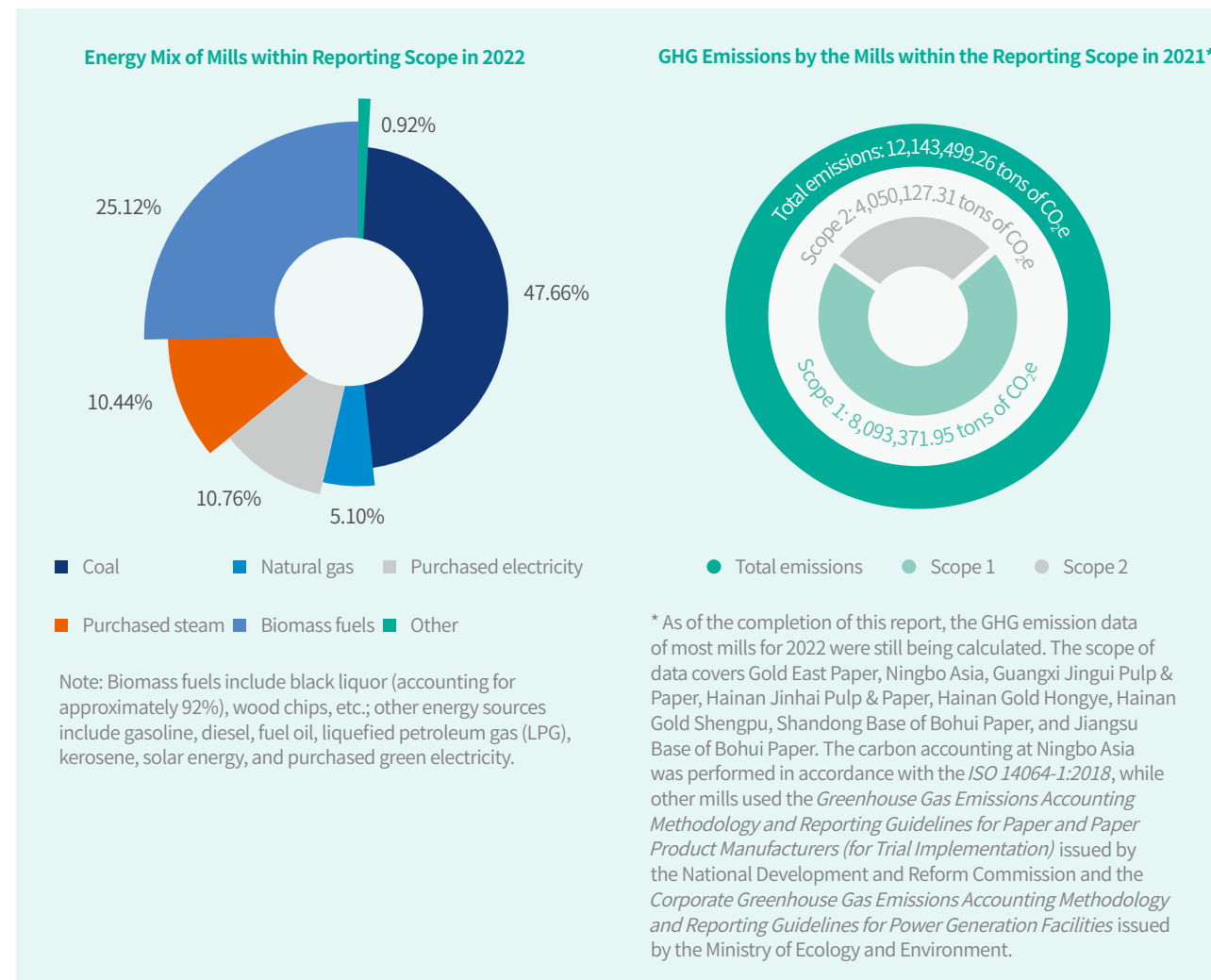

### • Building a Robust Energy Management System

Our mills have established their own energy management system that covers the procurement, storage, production, distribution, and utilization of energy in accordance with the requirements of the *Energy Management Systems* (GB/T 23331-2012) and the *Guideline for Energy Management in Industrial Enterprise* (GB/T 15587-2009). All mills have an Energy Management Committee to coordinate, plan, and arrange the energy management activities of both the mill and its departments, and conduct reviews of their energy management performance. The committee also formulates and implements energy performance improvement plans, and supervises the overall energy-saving and emission reduction management of each mill. As of the end of 2022, Rudong

Base, Hainan Jinhai Pulp & Paper, Bohui Paper, and Gold East Paper had obtained the ISO50001 Energy Management System certification.

All mills continuously strengthen their training efforts on energy management and energy-saving technologies, and regularly carry out relevant awareness raising and training events. To further improve its energy management performance, Hainan Jinhai Pulp & Paper conducted energy management training for mill managers, energy management system managers, and energy management technicians, etc., helping them solve practical problems and management difficulties encountered in the energy management process.

### • Transformation and Upgrading of Energy-saving Technologies

APP China continuously promotes the landing and application of energy-saving and emission reduction projects. Its mills have effectively improved energy efficiency and reduced energy consumption in production processes through energy-saving technical transformation projects such as process flow adjustment, equipment transformation and upgrading, deactivation of redundant machines, and recovery of waste heat and waste energy, bringing down their energy consumption

in the production processes, such as the unit consumption of electricity, steam and gas per paper machine. Hainan Jinhai Pulp & Paper, Guangxi Jingui Pulp & Paper and other mills actively respond to the digital and intelligent transformation strategy and green transformation strategy of APP China, and have started building online energy consumption and carbon emission management systems to promote the realization of visualized management of energy use.

#### Guangxi Jingui Pulp & Paper Significantly Improved Comprehensive Utilization Rate of Resources with Energy Management System

Guangxi Jingui Pulp & Paper has established an Energy Management System (EMS) and uses a Manufacturing Execution System (MES) to carry out real-time monitoring and statistical analysis of energy consumption of major energy-consuming equipment. The company has also developed a production consumption prediction model to monitor and automatically analyze the consumption of water, electricity, gas (steam), coal, fuel, and materials in real time, aiming to realize optimal scheduling, balance prediction, and effective management of energy and resources.

The system is able to calculate supply plan of coal based on production parameters and inventory information, automatically predict steam and electricity demand by inputting pulp and paper output plan into the steam and electricity balance model, and track energy consumption of each workshop in real time and remind them once their energy consumption exceeds the preset targets. In 2022, the comprehensive thermal efficiency of Guangxi Jingui Pulp & Paper's power plant was 66%, up 8% year-on-year.

#### Reducing Steam Consumption with Upgraded Steam Hood Paper Machine

The unit steam consumption of the steam hood paper machine at our Hainan mills was relatively high. In response to this, we conducted a detailed survey and analysis, and established a dedicated improvement team at the Company level. Through a number of improvement measures, such as repairing fan ducts, increasing tiered-utilization of flash distillation, and gas hood layout optimization, the heat loss of gas hood emissions

was successfully brought down, and the waste heat recovery rate of condensate water was also improved, saving 0.26 ton of steam per ton of paper produced, which was the equivalent to reducing carbon dioxide emissions by 15,692 tons per year. These technological upgrading measures had been applied to 12 steam hood tissue machines at our mills in Hainan, saving over 120,000 tons of steam annually.

#### Energy savings from energy efficiency retrofits implemented in 2022:

Gold East Paper: **3,687** tons of standard coal/year

Guangxi Jingui Pulp & Paper: **85,687.92** tons of standard coal/year

Ningbo Asia: **47,568.76** tons of standard coal/year

Hainan Jinhai Pulp & Paper: **6,444.22** tons of standard coal/year

Hainan Gold Hongye and Hainan Gold Shengpu: **6,565** tons of standard coal/year



• **Use of Renewable Energy**

Guided by the Company's "carbon peaking by 2030 and carbon neutrality by 2050" strategy, our mills have been vigorously promoting the use of photovoltaic power and purchased green electricity, and strengthening the efficient utilization of biomass energy such as bark, wood chips, and pulp residues to promote the green and low-carbon transformation of their energy structure.

Gold East Paper has started the construction of Phase III of its 20MW rooftop photovoltaic power station project, expected to reduce GHG emissions by 11,637.43 tons of carbon dioxide equivalent each year and generate an energy saving of 6,009 tons of standard coal. Ningbo Asia was planning for the construction of 15MW photovoltaic power station project, expected to reduce GHG emissions by 7,738.97 tons of carbon dioxide equivalent per year and save energy by 3,867.45 tons of standard coal.

Hainan Jinhai Pulp & Paper had established its biomass root/branch acceptance criteria, and actively explored

biomass fuel sources. It plans to increase its biomass fuel utilization to 400,000 tons per year. The company had also intensified its equipment upgrading to strengthen the capability to add biomass in fuels. Guangxi Jingui Pulp & Paper has carried out a biomass particle blending test project. In 2022, 142,083.5 tons of biomass such as wood chips, pulp residues, and sludge was blended and burned, an increase of 63,760.7 tons compared with 2021, and an increase of 81.41% year-on-year, achieving annual energy saving of 19,301 tons of standard coal and carbon emission reduction of 48,300 tons. In 2022, our mills within the reporting scope used a total of 3,516,670.13 tons of biomass fuels, including black liquor, bark, wood chips, roots, and pulp residues, up 10.46% year-on-year, accounting for 25.12% among the energy used.



Gold East Paper's rooftop photovoltaic power project

Solar power generation:  
**31.0242** million kWh,  
up **27.11%** year-on-year

Proportion of renewable energy:  
**25.63%**

Proportion of biomass fuel:  
**25.12%**

• **Product Carbon Footprint Verification**

APP China regards "reducing carbon intensity per unit product by 30% by 2030" as one of the important interim goals of the Company's "dual carbon" goals. Our mills subsequently enhanced the third-party verification of the carbon footprint throughout the whole life cycle of products.

In 2022, there were a number of products obtaining the "cradle to gate" carbon footprint certification, including the Breeze Blossom Zero-carbon Floral Essence Premium Roll Tissue and the VIRJOY zero-carbon tissue of Gold Hongye, the chemical-mechanical pulp and white cardboard paper from Guangxi Jingui Pulp & Paper, and the white ivory cardboard series, cultural paper, and corrugated cardboard paper of

Bohui Paper. Carbon footprint certification provides transparent and quantifiable carbon emission data from the acquisition and transportation of main and auxiliary raw materials, production and processing of products, to storage, packaging, and warehousing at various stages, which can help our mills to identify energy-saving and carbon emission reduction opportunities in key links of the value chain, develop practical and effective carbon emission reduction plans, and achieve better management of carbon emissions in the life cycle of our pulp and paper products.

**Guangxi Jingui Pulp & Paper Obtained 210,000 Green Electricity Certificates**



The green power trading mechanism is a systematic solution that uses market means to help achieve the "dual carbon" goals. It is an important support for industrial enterprises and the society to achieve carbon neutrality, as well as a key starting point for the rapid and healthy development of new energy. In 2022, Guangxi Jingui Pulp & Paper conducted green power trading through the Guangxi Electric Power Trading Center, purchasing 211.22 million kWh of green power and obtaining 210,000 green electricity certificates, which was the equivalent to reducing over 600,000 tons of standard coal, and reducing carbon dioxide emissions by 138,665.93 tons.



## Water Resources Management

APP China strictly implements national and local laws and regulations such as the *Water Law of the People's Republic of China*, the *Water Pollution Prevention and Control Law of the People's Republic of China*, and the *Water and Soil Conservation Law of the People's Republic of China*. The Company has established and continuously optimizes water resources management systems, including water conservation management systems and water conservation target accountability. Our mills have set up water conservation management groups to coordinate the comprehensive use of water resources and carry out effective water planning and water conservation measures.

Our mills have been increasing the reuse of rainwater, reclaimed water, and workshop white water through advanced water-saving equipment and technologies, aiming to reduce freshwater withdrawal and improving water efficiency. In 2022, the average industrial water reuse rate of the mills within the reporting scope reached 95%. In addition, our mills have tracked and analyzed water consumption data to detect and repair abnormal situations in a timely manner to prevent running, emitting, dropping, and leakage.

In 2022, APP China Paper Business Unit established a cross-department skill development activity to reduce water consumption per ton of product, with stage I and stage II reduction target set at 5% and 10% respectively. The project also aimed to improve white water reuse rate and reduce the freshwater replenish need through

measures such as adding white water filters and twin-roll press, and the high-efficiency reuse of condensate water. As a result, the water consumption per ton of product was reduced by 15% compared to 2021.

Bohui Paper, Guangxi Jingui Pulp & Paper and other mills carried out water balance tests to measure the data of water withdrawal, water use, water discharge, and water consumption and obtain a comprehensive mapping of water consumption to help identify water-saving potentials of each operation link. They also formulated feasible water-saving technical plans to comprehensively improve their water-saving capacity and performance.

In 2022, many APP China mills were recognized as national, provincial, or industrial park-level "Water Efficiency Front-

runner", among which, Guangxi Jingui Pulp & Paper, Hainan Jinhai Pulp & Paper, and Gold East Paper were awarded as national "Water Efficiency Front-runner".

Our mills have formulated wastewater management procedures and treat the wastewater in strict accordance with the *Discharge Standard of Water Pollutants for Pulp and Paper Industry* (GB 3544-2008), ensuring the concentrations of all pollutants to meet the relevant discharge standards, and even higher than national and local standards. All mills continuously optimize their wastewater treatment system, setting up online monitoring facilities at discharge outlets to monitor wastewater discharge in real time. In 2022, APP China mills achieved 100% compliance with wastewater discharge standards, with various indicators far below the requirements of industry standards.



Hainan Jinhai Pulp & Paper's wastewater treatment plant

## Wastewater Treatment Measures of Guangxi Jingui Pulp & Paper



### Alkali Recycling Project Put into Construction at Jiangsu Base of Bohui Paper

The chemi-mechanical pulp waste liquid comprehensive utilization project (also known as alkali recycling project) at Jiangsu Base of Bohui Paper started construction in February 2022. The system sends the wastewater from the chemi-mechanical pulping process to the alkali recycling workshop, where it is evaporated and concentrated before being burned in the alkali furnace, and then recovered the alkali from the pollutants through a causticizing process. Once the project become operational, except for a small amount of waste condensate water generated by the alkali recycling workshop, the chemi-mechanical pulp production line will no longer generate external wastewater discharge, achieving nearly zero discharge of pulping wastewater, and it is expected to generate an annual economic benefit of RMB185 million.

Indicator*	Unit	2022	2021	2020
Wastewater discharge per ton of paper produced (National standard ** limit: 20 tons)	ton	5.79	5.88	6.20
Wastewater discharge per ton of pulp produced (National standard limit for pulp enterprises: 50 tons; national standard limit for pulp & paper enterprises: 40 tons)	ton	9.60	12.46	12.50
COD emissions per ton of paper produced (National standard limit: 1.6kg)	kg	0.24	0.24	0.22
COD emissions per ton of pulp produced (National standard limit for pulp enterprises: 5 kg; national standard limit for pulp & paper enterprises: 3.6 kg)	kg	0.60	0.86	0.85

\*Not including the data of Rudong Base.

\*\*Discharge Standard of Water Pollutants for Pulp and Paper Industry (GB3544-2008)

## Air Pollutant Management

APP China mills continuously optimize their exhaust gases management procedures and strengthen the emission reduction management of exhaust gases such as SO<sub>2</sub>, NO<sub>x</sub>, and soot in compliance with national laws and regulations such as the *Law of the People's Republic of China on the Prevention and Control of Atmospheric Pollution*, the *Integrated Emission Standard for Air Pollutants* (GB 16297-1996), and the *Ambient Air Quality Standards* (GB 3095-2012), etc. Gold East Paper has consistently controlled the flue gas emissions of its power plant at the ultra-low emission level. In April 2022, Gold East Paper began implementing environmentally friendly emission reduction measures to further reduce the concentration of flue gas emissions from its power plant. In addition, the company also upgraded the storage yards for coal, ore, and wood chips, effectively reducing the emissions of unorganized exhaust gases. Because of these effective efforts to reduce emissions, Gold East Paper was recognized as "Zhenjiang City 2022 Air Pollution Prevention and Control Friendly Emission Reduction Advanced Unit".

### Ningbo Asia Built the "Odor-free Enterprise"

In 2021, a new residential community was built near the paper machine workshop of Ningbo Asia's Phase II project. Although the odor examination results at the mill's boundary met relevant standards, the newly moved-in residents sometimes still complained about foul odors when the air pressure was low and the wind blew towards the community. In response to this, the Beilun Branch of the Ningbo Municipal Bureau of Ecology and Environment proposed that as people's environmental awareness kept increasing, the existing standards for boundary odor examination also need upgrading to address the concerns of residents in nearby communities, suggesting the company to build a fresh mill by passing the smell test.

Ningbo Asia actively prepared a customized "one mill, one policy" plan for becoming odor-free. Based on existing treatment measures and a thorough screening of relevant factors such as raw materials, production process, exhaust points, and sources of odor, it was identified that paper machine drying exhaust gas as the focus of treatment. The plan also suggested several other treatment measures, including the source control of pulp auxiliary materials, adding fungicides to white water to reduce the growth of microorganisms, increasing the replacement of white water with clean water to reduce odor during cardboard drying, and adding deodorants for terminal treatment. The plan passed the expert review in September 2022. After the plan was implemented, the air quality in the surrounding communities had been effectively improved, and the incidents of complaints also dropped significantly.

### Exhaust Gases Emissions of Hainan Jinhai Pulp & Paper in 2022

Indicator	Permitted limit (ton)	Emissions in 2022 (ton)	Proportion (emissions in 2022 / permitted limit)
SO <sub>2</sub>	2,983	182	6.1%
NO <sub>x</sub>	5,303	2,586	48.7%
Soot	878	197	22.4%

## Solid Waste Management

APP China mills strictly comply with the requirements of national laws, regulations and standards such as the *Law of the People's Republic of China on the Prevention and Control of Environment Pollution by Solid Waste*, the *National Catalogue of Hazardous Wastes*, the *Standards for Pollution Control on the Storage and Disposal Site for General Industrial Solid Wastes* (GB 18599-2020), and the *Standard for Pollution Control Standard on Hazardous Waste Storage* (GB 18597-2001), and have formulated and revised relevant management procedures for non-hazardous solid waste and hazardous waste, specifying the classification, collection, storage, and treatment methods for non-hazardous solid waste and hazardous waste.

Adhering to the principle of "reduce, reuse, and resource utilization", all mills continuously intensify the resource utilization and comprehensive utilization of non-hazardous solid waste such as fly ash, pulp residues, sludge, lime sludge, gypsum, wood chips, and slurry. In 2022, the comprehensive utilization rate of non-hazardous solid waste at APP China mills within the reporting scope reached 99.37%.

Methods of Non-hazardous Solid Waste Disposal at Mills within Reporting Scope in 2022

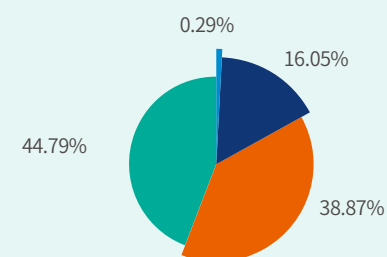

■ Recycling and reuse  
■ Selling to external parties for reuse  
■ Incineration  
■ Other

Note: "Recycling and reuse" refers to the recycling and reuse of waste through direct processing by APP China mills or through special cooperation with third-party agencies, such as making by-products from waste. Other disposal methods are mainly comprised of centralized treatment by local sanitation departments.

Energy Recovery from Solid Waste Incineration

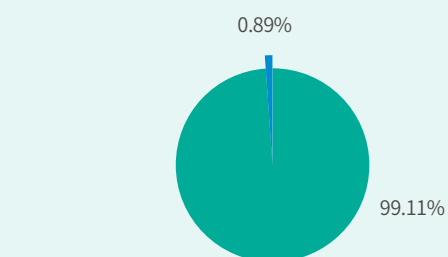

■ With energy recovery  
■ Without energy recovery

## Developing Green Logistics

APP China actively develops green logistics and has built a smart transportation system focusing on new energy, new technology, new management, and new models, optimizing logistics routes and increasing logistics efficiency with multimodal transportation, including ocean-rail, ocean-road, road-rail, and trunk line, and a "bulk-to-container" logistics mode, and achieving both cost savings and reduction of transportation carbon emissions. Hainan Jinhai Pulp & Paper increased the loading capacity of containers, while Rudong Base reduced the dismantling of the entire batch of goods and maximized the proportion of full-pallet loading, aiming to effectively reduce shipment frequency and the corresponding carbon emissions and other environmental impact of logistics operations. Bohui Paper implemented a project to switching from diesel forklifts to electric forklifts in 2022, effectively reducing the emissions of both air pollutants and GHG emissions.

### Bohui Paper Encouraging Carriers to Use New Energy Vehicles

Bohui Paper actively encouraged its carriers to use vehicles powered by natural gas, electricity or other clean energy. In 2022, Bohui Paper conducted a tram trial operation analysis of electric vehicles, which evaluated and analyzed indicators such as vehicle mileage, power consumption, transportation speed

in the simulated shipping routes, providing the data foundation and technical support for the adoption of electric vehicles. As of the end of 2022, the proportion of energy-saving vehicles in fleet of some carriers of Jiangsu Base of Bohui Paper reached 20%.



## Social:

### Adhering to the Original Aspiration of Shared and Win-win Development

Employee Development and Cultivation	60
Health and Safety	65
Product Responsibility	71
Customer Relationship Management	73
Charity and Philanthropy and Community Engagement	75



## Employee Development and Cultivation

### Our Commitment:

Fully protect the legitimate rights and interests of employees, establish clear career development paths, provide good career opportunities and resources for employees to achieve their career goals, encourage employees to take ownership, and ensure active engagement and in-depth participation of employees in the Company's business development through effective incentive mechanisms.

### Our Progress:

Percentage of female employees: <b>22.70%</b>	Established a professional technical career channel, form a "dual channel" with the management career channel
Percentage of female employees in management: <b>18.80%</b>	
Proportion of positions filled by internal recruitment and internal transfers: <b>52%</b>	<b>73</b> positions provided for people with disabilities
A total of <b>1,052,512.80</b> employee training hours, up <b>39.77%</b> year-on-year	

## Employee Rights Protection

APP China takes the *Labor Law of the People's Republic of China*, the *Labor Contract Law of the People's Republic of China*, the *Civil Code of the People's Republic of China*, and other relevant national and local laws and regulations as the basis for labor relationship management. Adhering to the principles of equality, voluntariness, and consensus through negotiation, APP China signs labor contracts with all employees, prohibits child labor and forced labor, ensures equal pay for equal work, and prevents any form of discrimination.

The Company provides employees with five social insurances and one housing fund, implements a salary system based on job posts with salary levels based on factors such as an employee's position,

qualifications, experience, performance, and capabilities. Meanwhile, the Company continuously optimizes and improves employee welfare benefits; our mills provide employees with various benefits based on actual conditions, including meal subsidies, high-temperature allowances, commercial insurance, birthday gifts, wedding gifts, maternity leave, and employee dormitories.

The Company also regularly organizes a variety of employee activities, such as basketball games, tug-of-war competitions, cultural performances, and artistic flower arrangement activities for female employees, etc., in order to promote a better work-life balance for the employees. To further enrich the after-work life of employees, Guangxi Jingui Pulp & Paper

established the Basketball Association, Badminton Association, Table Tennis Association, Billiards Association, Etiquette and Dance Association in 2022.

In addition, the Company actively listens and responds to employees' opinions and suggestions through organizing employee communication meetings, employee representative conferences, and employee satisfaction surveys, etc. In 2022, Guangxi Jingui Pulp & Paper, Bohui Paper, Gold East Paper carried out employee satisfaction surveys and formulated targeted improvement measures based on the survey results.

### Guangxi Jingui Pulp & Paper Carried out Employee Satisfaction Survey



To better understand employees' satisfaction and promptly identify and rectify gaps in employee management, Guangxi Jingui Pulp & Paper conducted a company-wide employee satisfaction survey in 2022. The survey focused on 32 indicators in 10 categories including job responsibilities, salary and benefits, training, working pressure, and labor intensity. A total of 2,077 online questionnaires were distributed, and 1,988 valid questionnaires were collected, resulting in a valid questionnaire return rate of 95.71%.

The survey results showed that the overall employee satisfaction in 2022 was relatively high, with a comprehensive score of 82.06 out of 100. In response to the management gaps identified, the company developed improvement plans and implementation strategies for relevant departments and positions to further enhance employees' recognition of the company, and continuously strengthen their sense of belonging and cohesion.

## Optimizing Career Development Path

As APP China accelerates the industrial upgrading process, the demand for technical talents grows significantly. In order to promote the comprehensive development and retention of technical talents, the Company established a professional and technical level assessment and development channel in 2022, forming a "dual channel" career development path in combination

with the management career channel. In 2022, a total of 203 employees from six major mills of APP China were promoted through the technical channel, greatly enhancing the motivation of employees.

In addition, APP China's mills support employees to better achieve career development through providing job

rotation opportunities, promotion based on a hierarchical system, and assisting new employees in formulating personal career plans. In 2022, within the scope of the report, there were a total of 2,486 positions opened, with 52% of them filled through internal recruitment and internal transfers.

### Implementing a Hierarchical Promotion Management System



In 2022, Guangxi Jingui Pulp & Paper started implementing a hierarchical employee promotion management system, strengthening the evaluation of employees' experience, capabilities, and performance while lowering the seniority threshold, and promoted a group of outstanding backbone employees.

The performance assessment of senior management is organized and implemented by the group headquarters.

The performance assessment of junior and middle-level management is based on the group headquarters' *Personal Performance Objective Setting and Assessment (PPO) Measures*. Individual performance indicators are formulated based on different job responsibilities, and employees are assessed semi-annually and annually regarding their performance and overall capabilities.

The performance assessment of grassroots employees is conducted by each department. Each department formulates internal assessment rules according to the company's *Personnel Assessment Management Measures*, and carries out monthly performance management and annual comprehensive assessment.

Performance assessment results are an important basis for adjusting employees' post levels. By reviewing how employees have achieved their performance objectives, the company works with employees to develop improvement plans to help them further clarify their future career development direction and goals.



APP China's digital and intelligent transformation strategy has entered the stage 2.0, which posts an urgent need for the cultivation of relevant talents. While introducing external training resources, we also hope to cultivate internal trainers who

are familiar with our business scenarios to better address the practical challenges of digitalizing business operations. In October 2022, we officially launched the Digital Intelligence Internal Trainer Development Program, which included online live course

training and coaching, in-person skills workshops, and rating certification, etc. The implementation of this project provides employees with opportunities to broaden their career development space and tap into more potential.

## Diversified Employee Training

We continuously improve our employee training system, providing diversified training for employees at different levels and in different business lines, supporting employees to enhance their professional

development skills in all aspects. In 2022, we integrated internal and external training resources, leveraging the role of internal role models and managers while strengthening cooperation with external

professional institutions and experts. We conducted various forms of training and sharing activities, such as "Expert Sharing", "Ignite Action", and "Managers as Cultural Navigators".

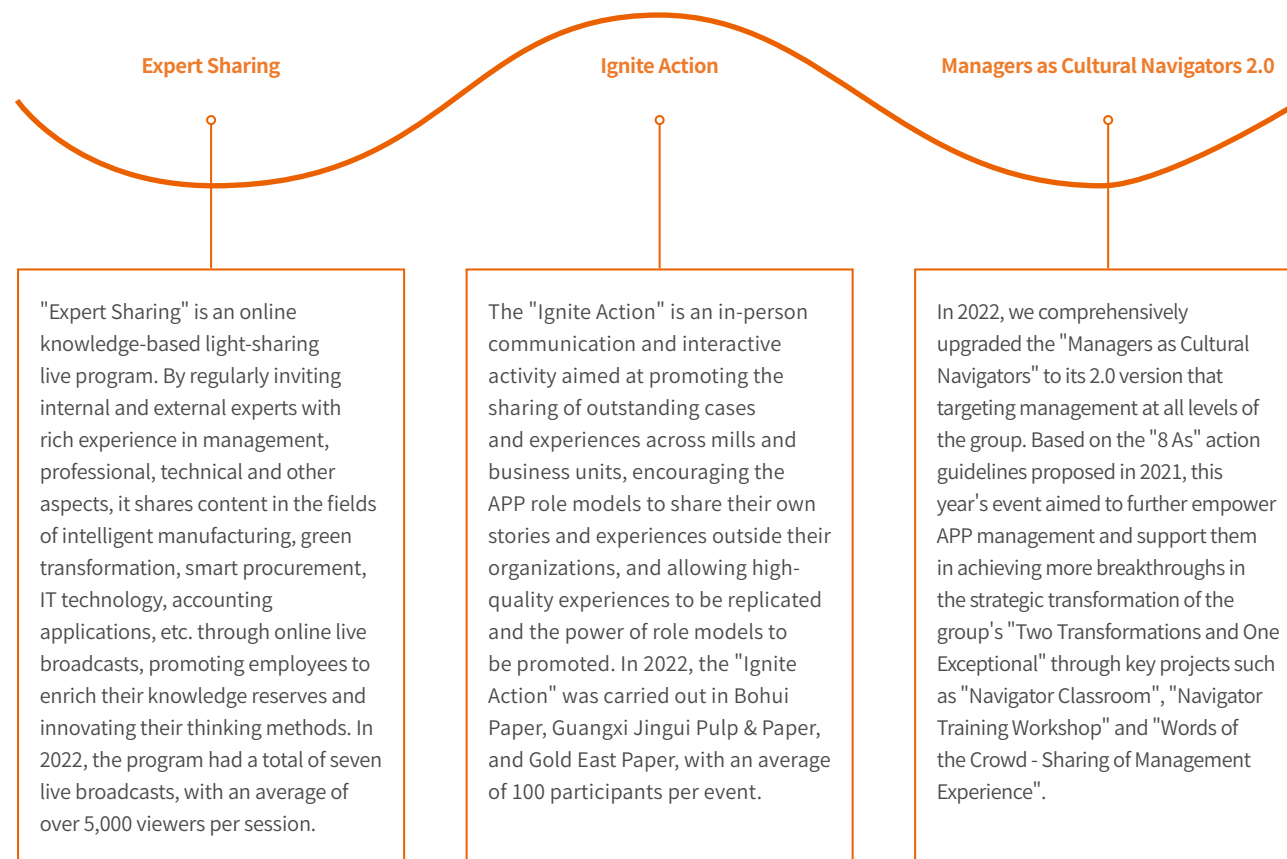

The APP Learning and Development Center conducted its annual training needs survey and found that all mills have training needs for newly appointed supervisors, who usually had urgent needs for systematic management training during their transition from managing themselves to managing teams. Regarding this, the Center referred to the survey findings and launched a

customized training program for newly promoted division-level supervisors of major mills in 2022. The program was carried out through a combination of in-person training and online courses, which were divided into three stages. Stage I focused on helping the newly-promoted supervisors clarify their roles and growth direction; stage II focused on systematic training and practicing of

management knowledge; and stage III concluded the entire training program with a summary and overall review of the training content. In 2022, the program was implemented in Ningbo Asia, Gold East Paper, Hainan Jinhai Pulp & Paper, and Guangxi Jingui Pulp & Paper, with a total of 120 participants.

### Promoting the Construction of Highly-skilled Talent Team



In order to upgrade the professional skills of technical talents and promote the construction of a team of highly-skilled talents, Ningbo Asia applied for and successfully obtained the qualification for recognition of senior technician vocational skill level for fitters and lathe operators at the end of 2021, and for electricians and boiler workers in July 2022, respectively. In 2022, Ningbo Asia carried out senior technician vocational skill level certification recognition for fitters, lathe operators, and electricians among employees. The assessment consisted of a theoretical test and a practical assessment. Students were required to participate in a combination of online and in-person knowledge training, as well as practical training and operational skill competitions on specific topics carried out by the company.

Officers from Municipal Human Resources and Social Security Bureau were invited to supervise the assessment process to ensure fairness and impartiality in the evaluation process.

In 2022, a total of 101 employees participated in the assessment of senior technician vocational skill level in the fields of fitter, lathe operator, and electrician. Among them, 88 people passed the assessment and obtained the senior technician vocational skill level certificate, with a pass rate of 87%. In the future, the company will continue to expand the scope of technician level certification qualifications to provide more opportunities and resources for the cultivation of technical talents.

### Organizing the "Hundred-Day Battle" Customized Training Program

In order to better cultivate and build up talent reserves, in June 2022, Gold East Paper selected grassroots and middle-level management with outstanding performance to participate in a customized training program. The program offered two training sessions, a "Bootcamp Class" and a "Voyage Class", for each category of participants. The two classes, totaling 66 employees, successfully completed the program after six months of training and learning, cultivating a group of departmental management backbone and key personnel for the company.

industry trends, as well as activities such as experience sharing sessions, seminars, and new volunteer activities project, aiming to cultivate the participants in both theoretical and practical aspects. To expose the participants to different perspectives, the program also invited senior management staff over the supervisor level as lecturers and organized a series of lecture salons from external experts.

The training offered customized in-person and online courses on management skills, workplace communication skills, corporate performance management, and papermaking

A total of 28 training sessions were organized for the "Hundred-Day Battle" program, with a total of 1,151 participants, each received 181 hours of training on average, and 220,000 words in their training assignments completed.

### Implementing Employee Cultivation and Development Plan

In 2022, Bohui Paper formulated a special personnel training and development plan based on the PM8 new paper machine project. After two months of recruitment and selection, more than 100 people participated in the two-week theoretical training offered by Qilu University of Technology, and 30 outstanding employees with active performance were selected to participate in external training. During the external training, the Company assigned a teacher to each student to ensure that they can master the paper machine operational skills through the one-to-one learning mode of teachers and apprentices. The lead supervisor was responsible for tracking the learning trends of students and instructing them to make a weekly learning summary. After two months of external training, the students were well prepared for the PM8 new paper machine service with a lot of job skills and practical experience.



Employees of Bohui Paper participated in training

## Motivating Employee Participation and Innovation

APP China has established and continuously optimizes its performance evaluation system with effective employee performance evaluation mechanism through methods such as setting annual goals, revising goals, and conducting outcome assessment at the beginning, middle, and the end of the year respectively, and conducting performance interviews with supervisors. The annual performance evaluation results will be reflected in annual bonuses, promotions, and salary raises for employees. In 2022, we further optimized our incentive policies,

including formulating a long-term talent retention plan and setting maximum annual distribution ceiling for bonus. The amount of bonus over the ceiling will be booked as long-term bonus for continuous distribution to ensure a more balanced and lasting incentive effect of employee bonus. In addition, we have formulated a variety of programs such as talent retention bonuses and equity incentive policies, to ensure our incentive policies fully covering senior management, middle and lower-level management, and professional and technical talents.

APP China encourages groupwide innovation with the culture of "Everyone is innovative and everything can be innovated". The Company actively encourages employees to participate in the strategic transformation of the Company, organizing MBOS proposal competition regularly, and promoting the sharing and replication of outstanding proposals internally through MBOS competition and regular achievement sharing sessions.

### Hainan Gold Hongye and Hainan Gold Shengpu Organized the 2022 Employee Proposal Competition



In 2022, Hainan Gold Hongye and Hainan Gold Shengpu collected a total of 2,328 improvement proposals from their employees. Among them, there were 18 outstanding proposals stood out during evaluation. In December 2022, these winning proposals, covering topics such as technological improvement,

quality improvement, equipment improvement, and process improvement, were publicly presented for sharing and recognition. This competition provided a communication platform to encourage frontline employees to innovate and accelerate the replication of best practices.



2022 Employee Proposal Competition of Hainan Gold Hongye and Hainan Gold Shengpu

## Health and Safety

### Our Commitment:

Regarding protecting employees' health and safety as our top priority, we have established and continuously optimize robust safety management mechanism, continuously strengthen safety management measures, ensure production safety, and actively focus on the prevention of occupational disease risks to fulfill the responsibility of occupational disease prevention and control.

### Our Progress:

Number of company-wide EHS surveys and inspections: **7**

Number of emergency drills: **795**

**631,233.5** hours of safety training carried out in total, up **40%** year-on-year

Average hazard rectification rate: **97.19%**

Total investment of RMB**10.5592** million in protective gears, up **14.46%** year-on-year

**41.48%** decrease in total lost worktime rate year-on-year

## Safety Management Mechanism

Focusing on the principle of "safety first, prevention-centered, and comprehensive management" and strictly in compliance with national laws and regulations on safety, health and environmental protection, APP China has established a unified safety, health and environment (SHE) management system covering all workers, production activities, and worksites, in line with relevant laws and regulations such as the *Law of the People's Republic of China on Work Safety*, the *Emergency Response Law of the People's Republic of China*, and the *Emergency Investigation and Handling Measures for Environmental Incidents*, etc. The Company has established a sound SHE organizational structure to ensure robust safety management. The system is led by the Management Committee at the company headquarters for strategic planning. The headquarters SHE Department formulates policies and coordinates with the EHS

departments of various business units for inspection and audit, system construction, and operation control. Each mill has established an EHS department, which is responsible for operation control, development of standard operating procedures (SOP), implementation of SOPs, on-site management, and regular audits.

In 2022, APP China revised the *Procedures for Project Safety Management and Control*, which stipulated the safety management procedures for all construction projects of the Company, including the establishment of safety management system, implementation of "three simultaneous" requirements (i.e. simultaneous design, construction, production and use), safety education and training, hazard source identification and risk assessment, audit and inspection, accident investigation and handling, etc. Meanwhile, the Company

continues to implement the APP China SHE group meeting program, which provides specific regulations on the content and format of regular meetings, ad hoc thematic meetings, and year-end summary meetings within the Company, aiming to facilitate smooth communication and exchange on SHE-related issues at our mills, analyze SHE management performance, and follow up on the formulation and implementation of countermeasures regarding major issues.

In order to establish a long-term mechanism for continuous improvement of SHE performance, in 2022, APP China launched a company-wide MBOS competitions around key indicators such as fatalities, government administrative penalties, total lost worktime rate, injury severity rate, fire incident rate, and occupational health abnormality rate, etc. The indicators of each mill were released publicly on a quarterly



basis, so as to encourage the mills to improve their SHE performance by analyzing weaknesses in management and adjust management strategies accordingly. As of the end of 2022, the Company recognized outstanding mills based on their annual indicator performance, and rewarded bonuses and honorary certificates to mills with outstanding achievement rates and no serious abnormality.

APP China's mills set annual production safety targets, including zero severe injury, zero fatality, zero fire incident,

zero occupational disease, zero major production safety accident hazard, and the implementation of monthly safety training and safety inspections. To achieve these targets, our mills strengthened their safety performance appraisal, carried out monthly appraisals, and took corresponding rewards and disciplinary measures based on appraisal results, aiming to continuously improve the awareness of production safety among employees with the appraisal mechanism that included safety performance in the performance appraisal of employees.

Our mills have been actively promoting the integration of standardization of production safety into their enterprise safety management system and enterprise standardization initiatives, aiming to ensure the implementation of each mill's main responsibility of production safety management by achieving full-process risk prevention and control and realizing traceable and scientific control procedures. As of the end of 2022, Ningbo Asia, Gold East Paper, Guangxi Jingui Pulp & Paper, Rudong Base had passed relevant rating reviews on standardization of production safety.

## Strengthening Safety Risk Management

### • Cultivating a Safety Culture

APP China Headquarters regularly organizes awareness-raising and training activities on safety, including safety training for management staff and case studies of response measures for typical SHE injury incidents, etc., to continuously improve the safety awareness of all employees and cultivate a safety culture. Our mills also continuously strengthen safety education with various measures and help employees at all levels to build a strong defense of safety awareness, including safety awareness

and skill training, safety accident warning education, safety knowledge competition, and special meetings on production safety, striving to lay a solid foundation for the Company to strengthen safety risk management and control, and improve safety hazard management and the capacity of emergency incident handling. In 2022, a total of 631,233.5 hours of safety training were collectively recorded at the mills within the reporting scope.

### Focusing on Systematized Management and Promoting Standardization of Safety Production



Rudong Base has formulated a series of production safety management systems in accordance with relevant laws and regulations such as the *Guideline of China Occupational Safety and Health Management System*, including the *Environmental Operation Control Procedures*, and the *Production Safety Rewards and Disciplinary Management System*, and the *Special Equipment and Special Operation Personnel Management*

*System*, and the *Safety Warning Sign Management System*, and the *Incident and Accident Management System*, etc., aiming to effectively improve its production safety level by strengthening risk management and process control with standardized, scientific, and systematic production safety management. In 2022, Rudong Base successfully passed the third level production safety standardization rating review of Nantong City.



High-end Tissue Base of Rudong Base

### Enhancing Employee Safety Awareness with Safety Culture Activities



In 2022, Guangxi Jingui Pulp & Paper organized a number of safety cultural activities to effectively cultivate safety awareness among employees, including safety training, pre-shift safety meeting system, employee safety knowledge competition, and safety culture communications via its internal publications.

Employee safety training	Pre-shift safety meeting system	Safety culture cultivation	Safety knowledge competition
Organized case studies on safety accidents to learn lessons and achieve effective safety warning education result. A total of 26 training sessions of various types were organized throughout the year.	Each department gave pre-shift safety briefings to employees through pre-shift meetings and safety tip cards to ensure that employees start their shift with sufficient attention to safety.	Organized the "Workplace Safety Month" and "119 Awareness Month" activities, published safety-related articles in internal publications, and distributed safety brochures and safety magazines to cultivate a strong safety culture.	During the Safety Month event in June, a total of 32 safety knowledge competitions were organized with 1,320 employees participating in. In addition, the company also organized its employees to compete in the knowledge contest activities on the new <i>Production Safety Law</i> of the Guangxi Autonomous Region.

### APP China Forestry Carried out Technical Training on Chemical Safety

In order to effectively prevent and control major safety risks involving hazardous chemicals and prevent the occurrence of related safety accidents, in September 2022, APP China Forestry Guangxi BU carried out a special technical training on chemical-related production safety management. The training focused on the content of the Chemical Safety Technical Specification that the company compiled based on relevant information from international organizations such as the International Programme on Chemical Safety, the International Agency for Research on Cancer, and the OECD Global Chemicals Information Platform. Employees improved their knowledge level of chemicals by learning about the composition and hazards, emergency measures, fire prevention measures, emergency response to leaks, storage, and disposal of chemicals, which helped ensure the safety of forestry production operations.



• **Safety Hazard and Emergency Management**

APP China has established and implements a dual prevention mechanism for safety risk classification and control, as well as safety hazard identification and rectification in accordance with relevant national and local laws and regulations such as the *Work Safety Law of the People's Republic of China*, aiming to eliminate production safety hazards in a timely manner. In 2022, our mills vigorously carried out safety hazard identification, special safety inspections, and pre-holiday safety inspections, etc., and adopted targeted rectification measures to manage and control safety hazards and build a solid line of defense for production safety. Guangxi Jingui Pulp & Paper started the construction of the dual prevention mechanism in 2022 through formulating specific implementation plans of the mechanism construction, improving and revising the *Administrative Measures for Safety Risk Hierarchical Management and Safety Hazard Identification*, identifying and inspecting key risk points, and strengthened hazard source evaluation and risk control, aiming to comprehensively improve the risk management and hazard identification and rectification capabilities of the company, and achieve the scientific, digitalized, and standardized prevention of accidents. In 2022, the average hazard rectification rate for all mills within the reporting scope was 97.19%.

In 2022, APP China Headquarters conducted seven EHS surveys and inspections on the identification and management of risk and the detection and rectification of safety hazards of all mills. Each mill was required to follow the rectification suggestions and receive follow-up inspections, so as to implement their main responsibility of EHS, form closed-loop management of production safety, and ensure the effective elimination of production safety risks and safety hazards.

Our mills continuously optimize emergency management measures, take actions to improve emergency handling procedures, build a regular emergency drill mechanism, and enhance employees' emergency response and handling capabilities for fires, oil spills, workshop forklift accidents, steam explosions and other emergencies. In 2022, a total of 795 emergency drills were conducted at our mills within the reporting scope. Experts from APP China Headquarters observed the emergency drills of seven mills, and put forward suggestions for improvement based on problems identified, which helped to further promote the standardized management of emergency drills.

• **Contractor Safety Management**

In recent years, APP China has been working with an increasing number of contractors. Due to the high mobility of contractor employees and the great variation in their safety awareness and operational standards, the Company continuously works to enhance contractor safety management and integrate contractors into the Company's SHE management system, ensuring effective supervision of the safety management of contractors with requirements in ten aspects, including eligibility review, signing of safety management agreement, safety training and safety notification, contractor meeting, management of high-risk operations, safety inspection and safety hazard identification, safety performance assessment, and accident reporting, etc.

Our mills actively implement the regulations of APP China Headquarters regarding safety management of contractors, and have formulated and continuously improve relevant safety management measures of contractors. In accordance with relevant laws and regulations such as the *Work Safety*

*Law of the People's Republic of China*, our mills sign a production safety management agreement with contractor to clarify the contractor's responsibility regarding safety management mechanism, safety inspection, safety education and training, and safety protection, etc. before the contractor starts operations, and urge the contractor to strictly follow the safety management agreement to ensure the compliance and safe operations during the contract period. For contractors work at our own mills, each mill will provide them with the necessary safety training before they start, and only those who pass the training assessment can have access to working at our mills, aiming to enhance the contractors' awareness of production safety. During their service at our mills, each mill continues to implement the requirements of contractor safety management on regular basis with measures such as regular contractor meetings, contractor assessment, and special inspections.

**Bohui Paper Continuously Launched the "I'm a Safety Personnel Today" Campaign**



Safety is seen from the tiny subtleties, and the comprehensive investigation and management of safety hazards depend on the joint engagement of all employees. Bohui Paper launched the "I am a safety officer today" activity in December 2021 to create an ideological atmosphere of "everyone is responsible and everyone is promising" for production safety. All employees actively

participated in the activity, carefully investigated the safety hazards in their positions, and supervised safety violation. By the end of 2022, a total of 305 safety violations had been detected in the activity, with the rectification rate exceeding 99%, achieving good results in hazard prevention and control.

**Hainan Jinhai Pulp & Paper Strengthened Contractor Safety Management**



Hainan Jinhai Pulp & Paper had implemented a series of management measures such as formulating its *Contractor Safety Management Measures* to effectively prevent the occurrence of contractor safety accidents. Before a contractor passes the eligibility review, its safety management status will be reviewed together with other information and any non-compliant items have to be rectified accordingly. Each month, the company carries out safety inspection of contractors, and issues a formal

notification regarding the issues founded and requires their rectification within certain period. The company organizes monthly meetings for project leaders and safety leaders of contractors to report their safety performance of the previous month and conducts case studies of accidents. Contractor personnel with violations will be required to rectify and receive disciplinary actions based on management protocols.



## Occupational Health Management

In compliance with the *Law of the People's Republic of China on Prevention and Control of Occupational Diseases* and the *Employer's Occupational Health Surveillance Measures On The Supervision*, APP China has formulated its own *Code of Occupational Health Management* and established a management system with the SHE Department of APP China Headquarters in charge of the overall management, EHS departments of business units conduct regular guidance and audit, and the EHS department of each mill manages their own occupational health-related issues. In 2022, the Company updated the *Code of Occupational Health Surveillance Management* and further elaborated on some of its requirements.

In compliance with the ISO45001 Occupational Health and Safety Management System, the *Law of the People's Republic of China on Prevention and Control of Occupational Diseases*, and other relevant occupational health laws and regulations, our mills implement various occupational health management

requirements to effectively fulfill their main responsibility on occupational disease prevention and control and reduce occupational hazards. The measures include establishing and optimizing occupational disease management system, organizing regular occupational health examinations, conducting occupational disease impact evaluation, organizing occupational hazards prevention and control training, distributing personal protective equipment, implementing the "three simultaneous" requirements (i.e. workplace safety, health and noise control measures must be simultaneous with the main project designed, constructed and put into production), and occupational disease reporting, etc. In 2022, there was no occupational disease incident occurred in units within the reporting scope.

The period from April 25 to May 1, 2022 was the 20th awareness week for the *Law on Prevention and Control of Occupational Diseases*. Our mills organized a series of activities, such as special training on the *Law on Prevention and Control of*

*Occupational Diseases*, lectures on the prevention and treatment of occupational diseases and chronic diseases, introduction to the occupational diseases prevention law, and online quiz on occupational health knowledge, to strengthen employees' awareness and prevention of occupational hazard factors. In 2022, our mills also actively organized regular occupational health training, such as training on occupational disease prevention and control law, health tips for high temperature, noise protection knowledge, and respiratory protection knowledge.

Hainan Jinhai Pulp & Paper and Guangxi Jingui Pulp & Paper contracted third-party institutions to inspect their workshops for occupational hazard factors such as toxic and harmful chemical factors, as well as high temperature, noise, and other physical factors, to accurately identify occupational hazards in workshops and take relevant measures to mitigate and control them. Guangxi Jingui Pulp & Paper was recognized the title of "Qinzhou Health Enterprise" in 2022.

## Product Responsibility

### Our Commitment:

We are committed to providing high-quality products for customers and consumers by focusing on full life cycle quality control, deeply implementing total quality management, and accelerating the development of a green product management system.

### Our Progress:

Continued to implement total quality management and encouraged the participation of all employees in improving product quality

Applied lean management system to strengthen product quality control

Focused on the development of a green product management system to ensure that products meet all health, safety, and environmental standards and requirements

### Hainan Jinhai Pulp & Paper Organized Free Health Consultation for Employees

In June 2022, Hainan Jinhai Pulp & Paper brought in experts from Hainan Cancer Hospital to provide health consultation for employees. Doctors and experts in the fields of cardiology, endocrinology, urology, osteology, oncology, traditional Chinese medicine, and gynecology provided diagnostic consultation for the employees. The employees also had blood glucose tests, thyroid color Doppler ultrasound examination, and other diagnostic procedures on-site.



Free health consultation for employees at Hainan Jinhai Pulp & Paper

APP China mills have established and continuously keep optimizing their respective quality management systems and related management policies and procedures in accordance with the ISO9001:2015 Quality Management System Standards. To continuously provide our customers with high-quality products, we have formulated and strictly implement a quality management mechanism that runs through the entire product life cycle, spanning from material procurement, manufacturing, and finished products, to sales, including raw material control procedures, inspection control procedures, product identification and traceability control procedures, unqualified product control procedures, potentially unsafe product control procedures, etc.



In September 2022, the "Breeze" brand won the "2022 Annual Craftsmanship Product in China Tissue Industry"

Our mills actively implement total quality management (TQM) and continuously strengthen the efforts to involve all employees to participate in quality management. In 2022, Gold East Paper upgraded its back-end inspection procedures for product quality, relying on the TQM quality management system that highlights upstream quality inspections from downstream upward. Downstream units were encouraged to identify issues in product appearance from upstream units for improvement. The Company also implemented a number of other measures to ensure the timely improvement of quality abnormalities, such as setting up a kanban management system for product appearance and quality, and forming a team led by supervisors for end-of-month warehouse quality review, etc. Bohui Paper had established a quality accountability system for each section, and actively organized activities such as experience exchange and skill competitions to continuously improve employees' product quality management capabilities. Hainan Gold Hongye and Hainan Gold Shengpu

organized 53 large-scale quality training sessions, with more than 1,600 employees received training in standardization advancement process, autonomous inspection, quality awareness, etc.

With the progress of digital and intelligent transformation, our mills have implemented lean management systems, which can automatically collect and record inspection data, promptly identify and handle unqualified products and quality abnormalities in the production process, and build correlations between the batch numbers for products in production, under inspection, and as finished products. With this complete set of complete and quick access to information on each batch of products, our mills are able to achieve total management of product quality by effectively overcoming the challenges of difficult statistics and analysis of manual recording of product quality.

Our mills also actively focus on the development of a green product management system and continuously

strengthen the management of the green attributes of raw materials. Based on the development and certification requirements for green products design, Gold Hongye Paper has developed specific requirements for suppliers of raw materials, such as pulp, non-woven fabrics, adhesives, chemicals, inks, and wallpaper substrates, etc., in the aspects of toxic and harmful substance content of raw materials, chemical content indicators, clean production and energy consumption, and health and environmental protection requirements. In addition, key suppliers are required to pass relevant certifications related to green products, such as forest certification, RoHS certification, as well as ISO9001, ISO14001, and ISO45001 management system certifications. Bohui Paper entrusts third-party testing agency to conduct annual product inspections regarding RoHS, SVHC, ozone depleting substances, and other prohibited substances to ensure that its products meet relevant health, safety, and environmental protection standards and requirements.



## Customer Relationship Management

### Our Commitment:

We are committed to adhering to a customer-oriented approach, maintaining smooth communication with customers, actively collecting and understanding customer feedback, and using technical exchanges and on-site technical services to provide customers with high-quality service experience.

### Our Progress:

Held **32** sessions of "Little A Classroom", reaching over **700** audiences

Continued to conduct customer satisfaction surveys and actively promoted improvement

Over the years, we have been continuously strengthening the tracking and handling of customer complaints. Through organizing discussions on the causes of customer complaints, developing corresponding improvement plans, conducting on-site visits and surveys of customers, and enhancing on-site audits of various production processes, we have deployed and implemented more targeted solutions for handling customer complaints, and continuously optimize the efficiency and quality of customer complaint handling by monitoring and evaluating the handling process as well as the effect of improvement. Meanwhile, we are committed to implementing our service concept of "Customer First" and helping customers solve various issues arising with the use of paper products through a variety of means, such as remote technical support, on-site technical support, and strengthening proactive services.

In 2022, APP China BUs conducted annual customer satisfaction survey. The survey aimed to understand customer feedback in dimensions such as product quality, sales service, logistics service, technical service, and information service and analyzed and summarized the trends in satisfaction scores. Meanwhile, issues identified during the survey were promptly rectified with follow-up reviews. In addition, our BUs maintained active communication with customers through regular customer visits and inviting customers to make field trips to the Company, so as to better understand their needs and expectations.

Since 2018, Paper Business Unit has been continuously holding the customer communication event "Little A Classroom", which provides customers with not only in-depth knowledge of our products, but also industry trends and technical knowledge and tips on the use of paper products. In 2022, Paper Business Unit

conducted a survey to learn about customer needs before launching this year's "Little A Classroom" event. Based on customer needs, the event focused on conducting in-depth exchanges with the personnel of the procurement, technology, production and other departments of customers over the topics of product characteristics, new product introduction, production process, printing and post-processing technology, and scientific paper use technologies, etc. Customer feedback was collected after the event for further optimization of the event content. In 2022, Paper Business Unit hosted a total of 32 "Little A Classroom" events, with an audience of more than 700 people.



### Empowering Customer Service Management with Digitalization



Guangxi Jingui Pulp & Paper takes a variety of digital intelligence measures to enable the customer service post-sales stage and effectively improve their customer experience.

<p><b>Establishing customer service database</b></p> <p>Established a customer database with professional digital systems to record the needs of customers, equipment conditions, and other information.</p>	<p><b>Building a comprehensive knowledge base</b></p> <p>Categorized frequently asked questions regarding paper and their solutions, product features, and product manuals, printing techniques, and precautions for unloading paper products, etc. into a series of documents under relevant topics and upload them to an online knowledge base, supporting the personnel to efficiently find the solutions for customers.</p>	<p><b>Initiating proactive promotion</b></p> <p>Communicated actively with customers about the methods to deal with the most commonly complained problems, such as bursting and delamination, using channels such as "Little A Classroom", WeChat moments, customer communication social media groups, technical exchange activities, and one-to-one communication, etc., to educate our customers on ways to avoid risks in advance and on improvement measures in case of such problems, and minimize losses for both customers and the mill.</p>	<p><b>Analyzing customer complaint indicators</b></p> <p>Conducted statistical analysis through the backstage online system on customer complaint indicators, such as customer complaint settlement amount, number of customer complaints, customer complaint rate, closing rate, and average time of customer complaints handling, etc., to urge the mill to improve paper product problems, stabilize the quality of paper products, and improve customer satisfaction.</p>
--	---	---	---



2022 "Little A Classroom" Event

## Charity and Philanthropy and Community Engagement

### Our Commitment:

Adhering to our original aspiration of charity and philanthropy, we have integrated our charity and philanthropy mission, which is to "help the frail, the needy, the elderly, and the young, and build a harmonious society", into our business operations and development, and continuously contribute to the harmonious development of society by actively supporting community development and engaging in public service in the areas of education support, national development, and poverty alleviation.

### Our Progress:

APP China has donated close to RMB**1.3** billion in charitable giving cumulatively in China

The "Dream Plan" charity projects recruited **90** new students, with a total enrollment of **179** students

Our Foundation implemented **29** charity projects, with a total donation of around RMB**137** million

Employee volunteer hours: **30,348** hours

### Continuously Expanding the Field of Charity projects

Huang Yicong Foundation (referred to as "the Foundation") has been focusing on providing long-term support for promoting equity in education, supporting youth development, and assisting medical and research advancement. The Foundation actively participates in the charity areas of education support, poverty alleviation and disaster relief, provides assistance to charity projects beneficial to national and social development in the fields of scientific research, culture and sports, medical care, and environmental protection, supports major development projects and research of the country, and promotes the development of philanthropy. In 2022, the Foundation added "rural revitalization"

as a new focus area, and started exploring the implementation of "carbon neutrality" projects.

The rural revitalization projects were mainly implemented around one of APP's Sustainability Roadmap: Vision 2030, which is to "improve the lives of millions", aiming to carry out rural revitalization practices through measures such as developing local industries, cultivating new agricultural businesses, and improving the efficiency of agricultural industry chains, so that the development results of enterprises could benefit local communities and farmers, and promote the advancement of China's rural revitalization strategy.



Scan the QR code to see more of the Foundation's practices

Part of Key Charity Projects of the Huang Yicong Foundation

Promoting Equity In Education

Sunshine Preschool

Since 2014, the Foundation has been collaborating with non-profit organizations specializing in early childhood education to implement the "Sunshine Preschool" Project in remote rural areas of Yunnan. The project provides preschool education for children aged three to six and helps local communities cultivate their own early childhood teachers and develop suitable early childhood education models, thereby promoting long-term development of local communities and helping them prosper. As of the end of 2022, the Foundation had supported 185 preschool classes in Ximeng, Funing, Lancang and Honghe in Yunnan, with a total of 4,316 children enrolled and 1,455 children graduated.

One Plus One Matching Fund

The Foundation launched the One Plus One Matching Fund project in 2012. APP China employee volunteers make monthly donations to provide financial assistance to primary and middle school students from impoverished families. Meanwhile, the Foundation also provides matching fund to support school construction and development. As of the end of 2022, the project had donated a total of approximately RMB2 million, provided financial assistance to 1,692 students in remote areas, and carried out a total of 20 supporting projects, such as individual assistance and relief cases, renovation of school facilities, and donation of books and musical instruments.

Supporting Youth Development

Huang Yicong Scholarship

Since 2002, APP China has established scholarships at multiple universities across China for students with outstanding academic performance and remarkable achievements to cultivate young talents. In 2011, the Foundation started including "charity and philanthropy" as an element of the project, adding a new requirement on the applicants' participation in charity activities, aiming to encourage college students to actively pay attention to and participate in charity and philanthropy. In 2019, the Foundation established "Huang Yicong scholarship" in Huaqiao University and Chinese Academy of Forestry for young talents with not only outstanding moral and academic performance, but also significant charity contributions or scientific research achievements. The Foundation has also been cooperating with partnering universities to explore more diversified programs to in-depth cultivate young talents. As of the end of 2022, a total of 2,616 students were awarded scholarships, with a total amount of approximately RMB7.4 million.

Yicong Internship

This program encourages college students to apply for summer internships at local non-profit organizations, allowing more college students to have the opportunity to understand the operation of charitable organizations and charity projects and discover different life values with this experience. Since its launch in 2010, this project has been successfully launched for 12 consecutive sessions in Shanghai, Nanjing, Beijing, the Pearl River Delta, Chengdu, Wuhan, and Tianjin. Over the past 12 years, a total of 558 outstanding college students have been selected as "Yicong Interns" and completed their internships with excellent performance, attracting attention from the charity sector.

Assisting Medical and Research Development

Geriatric Medicine Center

In accordance with the healthcare reform policies of the country and Shanghai, the Foundation has committed to donate RMB100 million from 2022 to 2025 to support Geriatric Medicine Center (Institute) of Ruijin Hospital to systematically carry out cooperation in high-level research, promote the development of geriatric medical disciplines, and cultivate outstanding clinical professionals and nursing talents in this field, so as to comprehensively cultivate elite health talents, strengthen medical collaboration and communication, and promote the high-quality development of services for the elderly. This project donated a total of RMB40 million in 2022.

Supporting Tsinghua University's Research on Carbon Neutrality and Green Finance

The Foundation has committed to donate RMB20 million to the Tsinghua University Education Foundation from 2022 to 2026. The funding will be used to fund the research work of the Institute for Carbon Neutrality of Tsinghua University on key carbon neutrality technologies, series of authoritative reports releases and talents cultivation, and accelerate the development of carbon neutrality policies and technological innovations. In 2022, the program donated a total of RMB4 million.

Rural Revitalization

Golden Orchard Program

The Foundation actively explored forest economy in accordance with the sustainability strategy of the Company, and took the lead in donating fund to support the pilot rural revitalization project of Xinfeng Golden Orchard Program in Ganzhou. The project conducted field studies in 2022, and plans to start construction in 2023. In the future, this project will cooperate with local farmers' cooperatives in Xinfeng to develop a specialty navel orange industry that integrates industrial ecological chains such as picking, deep processing, sightseeing, leisure, and culture and tourism, aiming to create employment opportunities for local communities, accelerate the growth of rural collective economy, and support local farmers' income generation. Based on preliminary calculation, by contracting production to farmers, this program is expected to benefit 2,620 farmers cumulatively over a four-year period, with an average income increase of RMB14,100.



Local farmers working in the navel orange orchard

The Dream Plan

Since its inception in 2018, the "Dream Plan" program has set up joint classes with Guangxi Vocational & Technical Institute of Industry, Nantong Vocational University, and Zibo Vocational Institute on mechatronics and electrical automation. The program also cooperated with the College of Light Industry and Food Engineering of Guangxi University, Zhejiang University of Science and Technology, and Qilu University of Technology to offer courses on pulp-making and papermaking. Students participating in this program are awarded a scholarship to cover their tuition and accommodation expenses, and an allowance to cover part of their living and transportation expenses. APP China provides with employment opportunities upon their graduation.

In 2022, the fifth "Dream Plan" program was launched in Guangxi and Shandong, with a total of 90 students selected from village and township middle schools in remote areas. As of the end of 2022, there were 179 students enrolled in the "Dream Plan", with 84 students

had already secured formal employment opportunities and another 66 students were doing internships. In the future, the "Dream Plan" will continue to expand the breadth and depth of school-enterprise cooperation, supporting students to receive systematic education in papermaking theory and practice, benefiting both the students by helping them realize their dreams and the papermaking industry by cultivating more applied talents for the industry.



The opening ceremony of 2022 "Dream Plan"

In 2022

Bohui Paper cooperated with Qilu University of Technology and Zibo Vocational Institute to provide full scholarships for 30 high school graduates to participate in the "Dream Plan" program.

Gold East Paper implemented the "Dream Plan" program with the coordination of APP China Headquarters, arranging for ten students from the Guangxi Dream Plan class to participate in a one-year on-the-job practical training at Gold East Paper.

Guangxi Jingui Pulp & Paper launched the "APP Class Dream Plan" summer internship program. The Human Resources Department worked together with the Pulp Production Department, the Paper Production Department, and the Pulp and Paper Engineering Department, formulating a detailed internship plan to help the interns fit in the company, further consolidate professional knowledge and familiarize specialist skills. There were 56 students from the 2021 APP Class participating in this internship program.



## Supporting Community Development

### • Cultural Dissemination

Ningbo Asia's Green Paper Culture Center opened in April 2021. Since then, it has already hosted 103 visits totaling over 1,100 visitors. Visitors could systematically learn about the history of paper making and APP China's green and low-carbon practices here. They also had the opportunity to participate in a manual-papermaking class to make paper with their own hands. In 2022, the company collaborated with nearby communities to carry out live cloud broadcast, allowing people to make virtual visit of the Green Paper Culture Center through live streaming. This new feature received widespread praise.



People could visit the Ningbo Asia's Green Paper Culture Center virtually through live streaming

### • Community Communication

Ningbo Asia organized 22 "Harmonious Community" activities in 2022, including inviting residents' representatives for mill visit, participating in special actions on community grassroots governance, donating books to kindergartens, communicating with voluntary environmental protection supervisors, and jointly carrying out festival celebration activities such as the Lantern Festival, the Dragon Boat Festival, and the Mid-Autumn Festival, so as to maintain harmonious neighborhood relations with local residents.



Ningbo Asia participated in special actions on community grassroots governance

### • Environmental Protection Campaigns

In response to the theme of "Work Together to Create a Clean and Beautiful World" of World Environment Day, Hainan Jinhai Pulp & Paper and Hainan Gold Hongye organized a variety of parent-child activities of "Environmental Protection Knowledge in Communities" in surrounding communities to promote the concept of ecological civilization, raise the awareness of community residents of World Environment Day, and spread environmental protection knowledge. The activities included garbage classification and identification, environmental protection poster painting, environmental protection knowledge quiz, etc. Employee volunteers also formed more than 10 beach cleaning teams and collected more than 20 bags of garbage, including broken glass bottles, plastic bottles, broken fishing nets, foamed plastics, waste electrical wires, etc., contributing to maintaining clean and beautiful beaches in local communities.



APP China volunteers cleaned up the trash on a local beach

### • Charity and Philanthropy

In August 2022, the Ningbo Beilun District "Two Mountains" Environmental Protection Public Welfare Foundation was established. Ningbo Asia donated RMB1.5 million to the foundation to support its activities and programs such as ecological environmental protection, ecological civilization construction, promoting green development, as well as environmental protection awareness raising and education.

Hainan Jinhai Pulp & Paper has long been a strong supporter of charity and philanthropy. In 2022, the company made several donations of teaching and office equipment, books, and tissue to local schools to support local education development. During the Spring Festival, its employee volunteers visited surrounding communities and brought gifts for to elderly residents, impoverished households, and children in welfare institutions. The company also donated funds to support the improvement of community cultural and sports facilities and the organization of basketball, volleyball, and chess competitions for local communities.

In August 2022, dozens of Gold East Paper employees participated in a voluntary blood donation, donating a total of 24,000 milliliters of blood. Over the past decade, Gold East Paper employees had made voluntary blood donations for nearly 1,600 person-times, with a total blood donation of 479,330 milliliters. It has been awarded the "Advanced Unit for Promoting Voluntary Blood Donation in Zhenjiang City" for consecutive years.



Hainan Jinhai Pulp & Paper donated Love Stools to Yangpu Experimental Primary School



Gold East Paper employees participated in blood donating





# Economic and Governance:

## Building a Solid Foundation for Sustainable Development

Digital and Intelligent Transformation	82
R&D and Innovation	88
Risk Management	92
Business Integrity and Ethics	94
Supply Chain Management	98

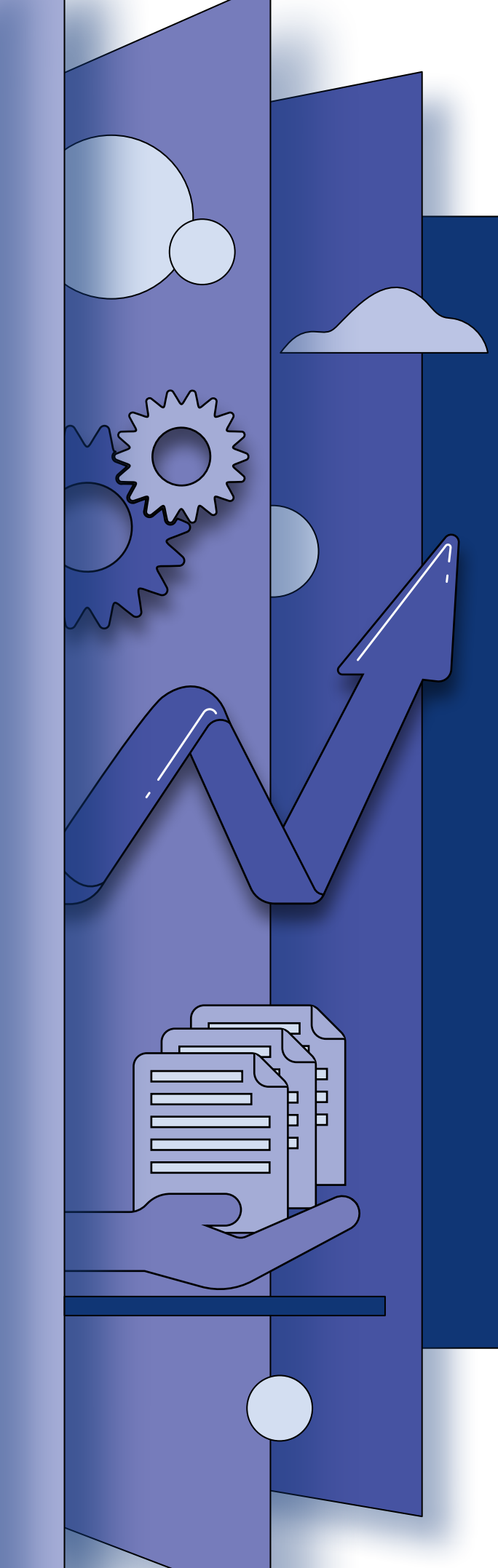
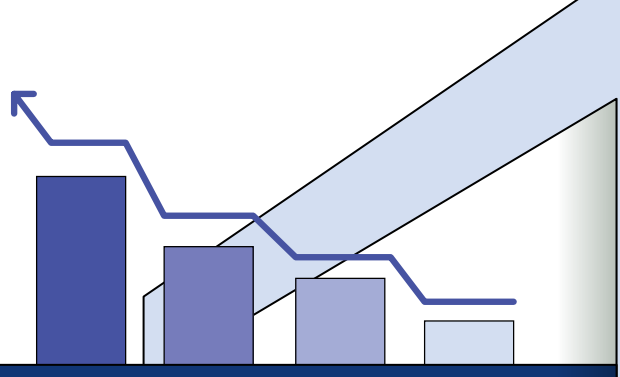



# Digital and Intelligent Transformation

## Our Commitment:

We strive to promote comprehensive upgrading of production and operation efficiency by actively promoting digital and intelligent transformation, intensifying the analysis and application of big data, implementing data-driven decision-making, management and innovation, and focusing on artificial intelligence applications and intelligent manufacturing.

## Our Progress:

Our **Digital and Intelligent 2.0** project has entered the stage of in-depth development

Our mills have completed the implementation of the lean management system, which has significantly improved their operational efficiency

Rudong Base continuously improved the capabilities of its logistics system, such as moving shipment into and out of its automated warehouse and managing the inventory in storage. Its warehouse capacity has increased by **4.75** times and has achieved the capability of one-stop loading

In the context of Industry 4.0, digital and intelligent transformation has become an inevitable choice for traditional enterprises. It is not only a megatrend of social and economic development, but also a crucial foundation that supports our technological innovation in the future. APP China actively explores the direction of digital and intelligent management, and strives to integrate digital and intelligent transformation into its core strategy. After years of implementation, APP China has completed the construction and optimization of the deployment of Digital and Intelligent 1.0, including the comprehensive coverage of enterprise resource planning (ERP), manufacturing execution system (MES), office automation (OA), and APP transportation management system (ATMS). Now, we have already

steadily stepped into Digital and Intelligent 2.0. In 2022, our mills had made great achievements in the rolling out of digital and intelligent development and won many national and local honors.

Driven by business needs, our transformation towards Digital and Intelligent 2.0 empowers our business processes, such as sales, production, quality management, supply chain, logistics, equipment maintenance, etc., with various digital and intelligent measures to optimize management and processes. We also carried out data analysis to obtain insight to further improve the effectiveness of our development strategy.

In order to implement the Digital and Intelligent 2.0 strategy, our BUs, mills and

Headquarters departments will establish dedicated working groups to provide guidance for the implementation of various digitalization projects within the Company. Meanwhile, the Company will also organize MBOS competitions on digital and intelligent transformation to encourage the replication of outstanding application scenarios among our mills, so as to achieve more extensive and in-depth application of artificial intelligence, big data, the Internet of Things, and intelligent automation technologies.

## The Digital and Intelligent Transformation Strategy of APP China

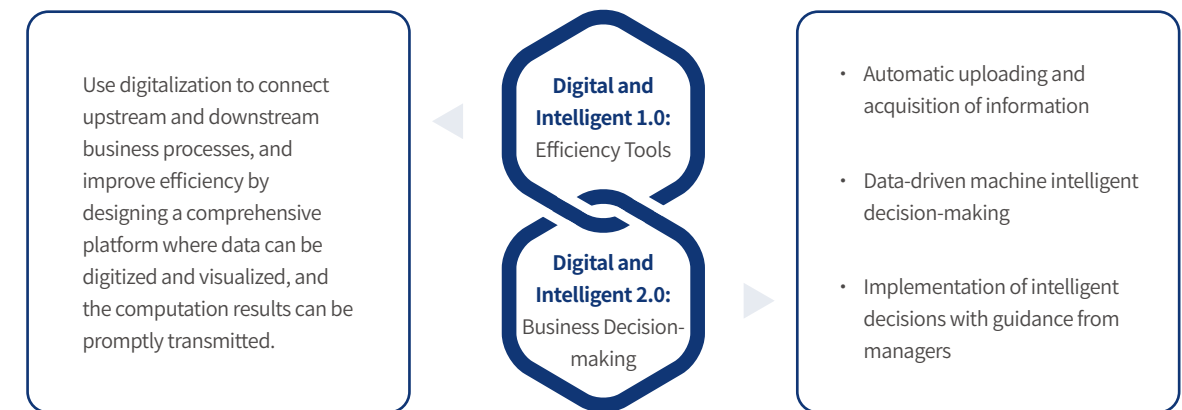

## Planning Highlights of APP China's Intelligent Production Line

### 01 Pulping

Using unmanned transporter cranes and conveying system to replace forklift

Using automatic wire cutting and automatic wire detection equipment to effectively reduce the need for labor



### 03 Processing

Using fully automated packing and boxing equipment

Application of industrial visual detection technology

Complete adoption of intelligent automatic guided vehicles (AGV) for product handling



### 02 Paper-making

Using rail guided vehicles (RGV) to move base paper directly to the workshop

Using RGV to move base paper and empty rolls across workshops

Using Radio Frequency Identification (RFID) to track the production and inventory information of each roll of paper

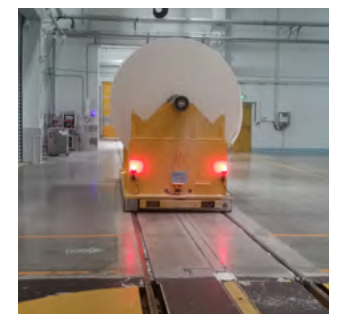

### 04 Warehousing

Using fully automated loading and unloading vehicles and equipment

Establishing a Warehouse Management System

Construction of fully automatic stereoscopic warehouse





Automatic paper reeling balers

### Rudong Base Steadily Implemented Digital and Intelligent Development



Based on the design concept of Industry 4.0, APP China is committed to building Rudong Base into a world-class intelligent papermaking base that is safe, efficient, low-cost, and environmentally friendly. The project was planned to be constructed in three phases, with a total planned area of 8,500 *mu* and planned annual production capacity of 3.96 million tons of high-grade tissue. In 2022, there were seven production lines of Phase 1 of the project completed, with production capacity totaling 780,000 tons.

Rudong Base was designed to achieve an intelligent and modular production mode from raw materials to shipment (including port, pulp warehouse, papermaking workshop, processing workshop, and automated warehouse). Regarding its general layout, Rudong Base adopted diversion designs and used a one-directional loop design for the main route, to improve its overall traffic efficiency. As of the end of 2022, Rudong Base had fully implemented its lean management system, achieved full coverage of 5G network, and adopted a series of digital and intelligent initiatives, such as automatic pulp feeding, intelligent handling, traceability tracking, automated assembly lines, intelligent handling robots, and intelligent logistics.

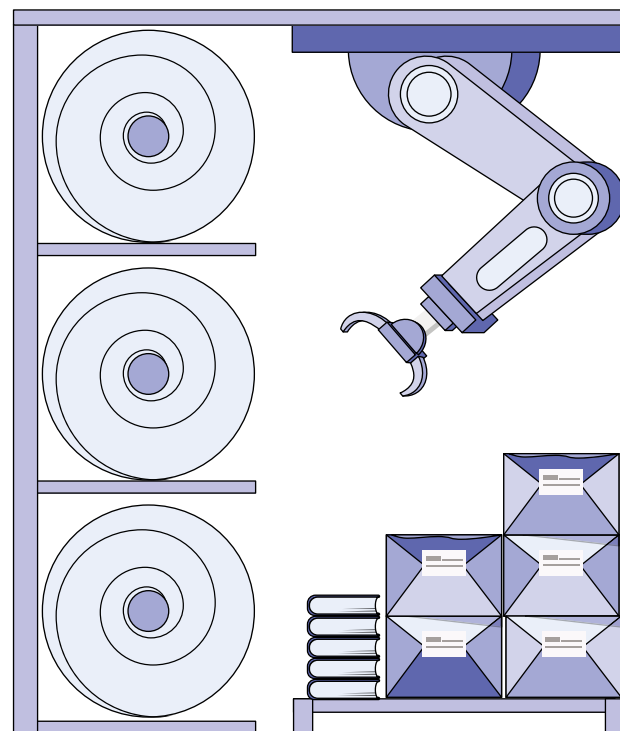

### Bohui Paper's Lean Management System Became Fully Operational



Bohui Paper is committed to building a green, low-carbon, digitalized and intelligent mill. It adheres to the principles of technological innovation and green and low-carbon circular economy, and continuously implements management reform to promote the construction of digitalized and intelligent mill.

In 2022, Bohui Paper's digital and intelligent transformation project, the Lean Management Project, became fully operational, and has already started showing the advantages of digital, intelligent and standardized fine management.

#### Effects of Jiangsu Base of Bohui Paper's Intelligent Mill

##### Planning and scheduling

Realized fast production scheduling and timely response to demand changes.

Realized transparent and refined management of all production processes, and managers can realize timely error prevention and advance management based on real-time production data, which significantly reduces production costs and improves production efficiency.

##### Production and operations

##### Warehousing and distribution

Implemented the Warehouse Management System, and adopted intelligent warehouse equipment, such as automatic paper reeling balers and automatic warehouses, to realize automatic management of the raw materials and products out of and entering the warehouse, effectively optimize the warehouse management process, and promote the efficient use of warehouse resources.

Improved the timeliness of production process quality control and product control capabilities by monitoring, predicting and managing product quality along the whole production process.

Carried out blind sample testing for the inspection of incoming raw materials to avoid the risk of losses due to biased inspection results.

Avoided the risk of missed inspection and the risk of unqualified raw materials entering the production process.

##### Quality control

##### Energy, environmental protection and safety management

Achieved energy conservation and consumption reduction through timely adjustment of production processes and workflows in accordance with the online monitoring results of energy consumption, water consumption, and other resource consumption.

Achieved effective environmental management and control with the automatic monitoring of wastewater discharges, online monitoring of wastewater volume, and the lifecycle monitoring of hazardous waste.

Realized gridded and digitalized safety control by automatically controlling and recording the conditions of major hazards and adding intelligent safety facilities.

### Guangxi Jingui Pulp & Paper Improved R&D Efficiency with Digital and Intelligent System

Guangxi Jingui Pulp & Paper's R&D Department used an automated system to replace repetitive labor by connecting front-end business, product, R&D, and operation with a series of software systems such as production manufacturing execution system (MES), production big data generation, big data analysis, and equipment dynamic management system, etc. By using these systems, R&D personnel were able to not only retrieve and analyze data and information, such as product quality, chemical use, equipment operation status, etc., at any time, but also use the trend analysis function of the systems to predict possible problems customers might come across when they use the product, and make timely adjustment to the production process to optimize product quality. As the digital and intelligent systems were used with increasing proficiency, the company's R&D cycle has been effectively shortened.



### Gold East Paper Implemented the Warehouse Management System



Gold East Paper achieved positive results with digitalized management of its warehousing operations, including warehousing operation, shipment operation, shipment risk control, the Extended Warehouse Management (EWM) system and the independently developed APP Transportation Management System (ATMS).

#### Warehousing Operation



Increase warehousing efficiency by 25% through automated and refined management; and significantly reduce reworking by effectively eliminating unreasonable reworking.

#### Shipping Operation

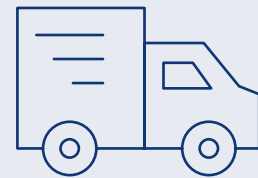

Improve order picking efficiency, shipping order printing efficiency, and the packing efficiency by 87%, 25%, and 10% respectively through reducing manual operations and streamlining work processes.

#### Shipping Risk Control



Automatically check the data consistency of each link in the shipment process, and conduct credit checks on customers at four control points during the shipment operation, including creating order picking lists, printing shipping orders, transmitting release orders, and system posting. As a result, the accuracy rate of matching the shipment quantity with the sales delivery order has reached 100%.

#### Interactive Access Management with EWM and ATMS



Vehicles with appointments can get access by using the appointment number to query its vehicle information and check-in status.

After the shipment loading review is finished, the shipment information release document is transmitted to ATMS in real-time.

An empty vehicle is weighed when it enters the mill, and then gets weighed for the second time after the shipment has been completed. If any abnormality is detected, the vehicle will be weighed again for verification. If the problem persists, personnel from product, security, and quality assurance departments will be involved in the inspection to fully prevent operational violations.

### Developing Smart Forestry



APP China Forestry continuously improves afforestation and logging efficiency with the increased application of mechanized tools. In 2022, full mechanical cutting accounted for 16% of all cutting operations, up 6% compared with 2020; mechanical afforestation accounted for 61% of all afforestation operations, up 21% compared with 2020. Meanwhile, drones had been used in the whole cycle of forestry operations, including land acquisition, planning,

afforestation, nurturing, management, and logging, effectively improving the digital and intelligent operational capabilities of forestry. By using digital technologies such as logging area monitoring, yard monitoring equipment, GPS monitoring and transmission technology, the Company was able to realize visualized forest management, reduce the risk of timber loss, and ensure timber safety.

#### APP China's Application of Drone Technology in Forest Management



\* "Three Preventions" refers to prevention of fire, prevention of illegal logging, and prevention of land occupation.



Forest land patrol with drones

In November 2022, APP China launched the Forestry Lean Management Project and conducted research in APP China Forestry Guangxi BU in preparation of the construction of a Smart Forestry Management Platform. The project was designed to cover the requirements of the entire forestry operation, such as land acquisition, small shift operation design, GIS cartography, logging-afforestation-nurturing operations, seedlings cultivation, asset management, quality control, resource survey, and accounting and finance, etc.

## R&D and Innovation

### Our Commitment:

APP China constantly optimizes our R&D mechanisms, improves development capabilities regarding core technologies, and continuously explores the development of green and environmentally friendly products, aiming to use our paper products to better serve people's pursuit for a better life.

### Our Progress:

2022 R&D investment RMB3.138 billion, up 28.83% year-on-year

1,097 patents granted cumulatively

## R&D Mechanism Construction

R&D and innovation are important ways for enterprises to enhance their core competitiveness. We are committed to continuously strengthening our R&D and innovation capabilities through process improvement, project construction, talent

cultivation, and new product development. In 2022, the R&D investment of all units within the reporting scope totaled RMB3.138 billion. As of the end of 2022, the total cumulative number of validly authorized patents was 1,097, including 499 invention

patents, 17 assigned invention patents, 442 utility model patents, and 139 design patents. In addition, we also had 139 patents in the process of application.

### APP China's R&D Focuses

Process Improvement	Project Construction	Talent Cultivation	New Product Development
Utilizing the MBOS management platform to urge our mills to cut costs and improve efficiency, such as energy recovery and reuse, technological upgrading and transformation, etc.	Vigorously adopting new digital and intelligent technologies, accelerating the digital and intelligent transformation of our mills, and carrying out digital and intelligent transformation planning for new expansion projects.  Following the trend of low-carbon and environmental friendliness, we vigorously promote the application of new energy-saving and emission-reduction technologies, and strive to make all mills recognized as a Green Factory.	Strengthening the cultivation of diversified technical personnel and building a high-quality team with strong comprehensive capabilities as well as hands-on problem-solving experience.  Strengthening incentives and rewards for R&D talents to promote the enhancement of independent innovation capabilities.	Product designing with priorities given to product attributes such as low carbon, environmentally friendliness, and biodegradability.  Developing new materials to replace specific chemicals, improving processes, and reducing chemical usage.  Intensifying new product development and enhancing product functionalities.

### Bohui Paper Passed the "Zibo Engineering Research Center for New Materials for Papermaking"

In September 2022, Bohui Paper successfully passed the "Zibo Engineering Research Center for New Materials for Papermaking" certification. The research center was a joint program between Bohui Paper and Tianjin University of Science & Technology, aiming to promote the close integration of technology R&D and production, and support the company's development in terms of technology strategies and technology management.

### Hainan Jinhai Pulp & Paper Was Recognized as a "Provincial Enterprise Technology Center"

After a comprehensive evaluation of Hainan Jinhai Pulp & Paper's performance in innovation investment, innovation talent, technology accumulation, innovation platform, technology output, and innovation outcomes, the company was officially recognized as a "Provincial Enterprise Technology Center" jointly recognized by Hainan Provincial Development and Reform Commission in December 2022.

## Intellectual Property Management

APP China strictly abides by applicable laws, regulations and provisions, such as the *Patent Law of the People's Republic of China*, the *Trademark Law of the People's Republic of China*, the *Copyright Law of the People's Republic of China*, the *Registration of Computer Software Copyright Procedures*, etc. and has formulated and continuously optimizes relevant policies such as the

*Intellectual Property Rights Management Measures* and the *Patent Management Operation Procedures*, etc. Our intellectual property-related policies cover patent rights, copyrights, trademark rights, and trade secrets, etc., aiming to protect the legitimate rights and interests of all units of APP China, encourage employees to invent, innovate and create, and enhance the innovation

capabilities of the Company. These policies regulate the code of conduct for employees in terms of intellectual property rights, ensuring the protection of both our own intellectual property rights and the intellectual property rights that belong to others.

## Product Innovation

APP China maintains an unwavering commitment to providing customers and consumers with high-quality products. As the concept of sustainable development increasingly penetrates into various aspects of economic and social development, we are also intensifying our efforts to explore and develop products that are more environmentally friendly, healthy, and safe, and provide customers and consumers with satisfactory user experience.

### Gold East Paper Reduced Fluorescent Brightener Use in Copy Paper Product

When producing high-brightness paper, not only a large amount of fluorescent brightener needs to be added to the pulp, but also a high-sulfonic acid brightener needs to be used in surface sizing and coating. In order to minimize the use of fluorescent brightener, Gold East Paper analyzed and researched the

dosage of fluorescent brightener, and effectively reduced the amount of fluorescent brightener added during the production process by adopting innovative papermaking processes and adjusting the raw material mix, further reducing the negative impact on the environment.



### Guangxi Jingui Pulp & Paper Developed Low-odor, Ultra-high Bulk Coated Refrigeration White Cardboard Product



Plastic packaging still plays a significant role in the current cold chain logistics industry. Regarding this need, Guangxi Jingui Pulp & Paper developed an ultra-high bulk coated refrigeration white cardboard product, which helps the cold chain logistics industry reduce the use of plastic packaging. After the product was launched, it received widespread recognition from customers.

In this regard, the company investigated the possible sources of the odor, such as raw materials used or food-grade chemicals added in the production process, and concluded that there was a relatively high correlation with the cleanliness of chemi-mechanical pulp. The company quickly formulated and implemented an improvement plan and got rid of the odor, achieving a steady increase in order volume while meeting customer needs.

In addition, customers were asking for increasingly stringent requirements for the odor aspect of such

### VIRJOY Food Care Wipes

In order to actively respond to the increasingly refined needs of consumers for healthy living, Gold Hongye Paper had successfully developed and launched the VIRJOY Food Care wipes product. This product only contains EDI pure water and

food-grade ingredients. It has passed third-party professional testing, including an acute oral toxicity test. It can be safely used to clean food, tableware, and hands, making it a convenient item for everyday travel.



VIRJOY Food Care wipes

### VIRJOY Gentle Bio Wipes Products



In 2022, Gold Hongye Paper developed and launched the VIRJOY Gentle Bio wipes products, including pure water wipes, toilet wipes, and kitchen wipes. This product was developed by applying the composite Staphylococcus aureus enzyme technology in wipes products.

This internationally pioneering and domestically exclusive biocatalytic antibacterial technology, which has multiple world-class patents, is the result of 30 years of research by the Institute of Biological Science of Fudan University. This biological enzyme can directly crack the peptide chain of the bacterial cell wall peptidoglycan, which destroys the integrity of bacterial cell wall to achieve the intended sterilization effect. This mechanism is also less prone to create drug resistant bacteria. Because biological enzyme itself is a protein, it will degrade into amino acids and water afterwards with no accumulation and residue in human body, making the product safe and environmentally friendly.



VIRJOY Gentle Bio wipes

### Bohui Paper's Unbleached Single-sided Coated White Ivory Cardboard Passed Green Footprint Evaluation

The unbleached single-sided coated white ivory cardboard product of Jiangsu Base of Bohui Paper had passed the "Green Footprint Evaluation" of China Quality Certification Center. The certification was carried out in accordance with the evaluation indicators in the Technical Specification for Green-design Product Assessment-Packaging Paper and Cardboard issued by China National Light Industry Council. As a green product, this product has the following characteristics:

It reduces the consumption of coniferous wood and pollution from the bleaching work in the pulping process by using unbleached chemi-mechanical pulp and low-brightness broadleaf pulp.

There is no fluorescent brightener in the pulp. Brightener is only used in the coating process, which 100% stays on the surface of the paper and does not enter the water system.

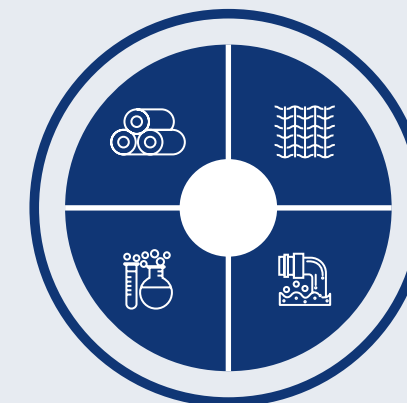

Pulp consumption per unit of this product is 15% lower than that of regular white cardboard, reducing the consumption of wood pulp fibers.

There is no sizing in the pulp. The product uses surface sizing technology to control its water absorption rate, which improves the cleanliness of the white water generated and reduces the difficulty of wastewater treatment.

# Risk Management

### Our Commitment:

APP China is committed to continuously optimizing our risk management and internal control system, and inspecting and evaluating the effectiveness of its corporate governance, risk management, and internal control. The Company also ensures stable and sustainable operations by intensifying the application of digital technology and enhancing risk management capabilities and efficiency.

### Our Progress:

Completed **26** internal audits

Completed the digitalization audits of **23** scenarios to effectively ensure the compliance and advancement of the digital and intelligent projects

Continuously improve information security governance, to build a solid foundation for the Company's sustainable operations in the context of digital and intelligent development

## Risk Management System

APP China has established the "Three Lines of Defense for Internal Control" management system to effectively prevent and control business risks. In 2022, the Company focused on risk prevention and carried out 26 internal audits for the Group's forestry, pulp, paper, chemical and other business units, and ensured the implementation of value-added efficiency improvement and rectification activities based on audit findings, with 15 procedural documents drafted or revised during the

process. Meanwhile, the Company also audited the enterprise risk management control points in existing processes by using big data technology, and used its big data platform to continuously monitor the risks identified, so as to form a long-term risk management mechanism.

The Company also conducted targeted audits of its entire procurement and sales processes regarding its digital and intelligent projects. The audits identified a number

of deficiencies in process control and compliance management, and proposed relevant rectification suggestions and tracked the rectification process. In 2022, the Company had completed the digitalization audits for 23 scenarios, including sales-related scenarios, logistics scenarios, raw material procurement, weighing, and entering-warehousing scenarios, and finished product shipment scenarios, to comprehensively prevent operational risks in digital and intelligent projects.

### 2022

The Company focused on risk prevention and carried out **26** internal audits for the Group's forestry, pulp, paper, chemical and other business units

### APP China's Three Lines of Defense for Internal Control

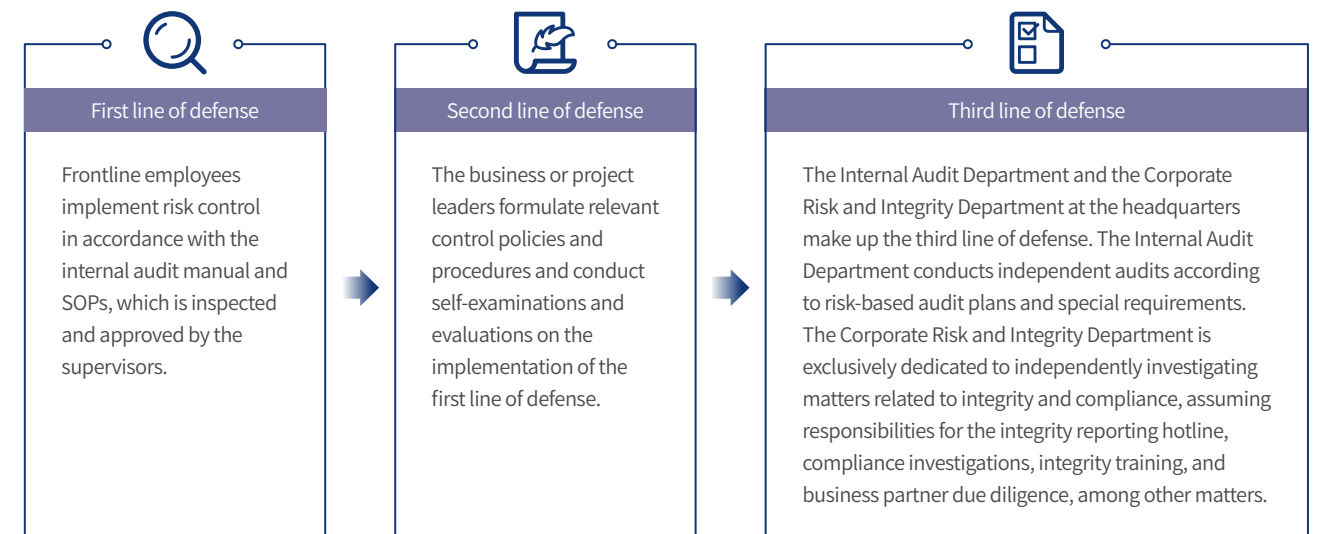

## Information Security Risk Management

APP China has built a company-wide IT infrastructure and information security management system consistent with the ISO27001 Information Security Management System, and formulated a series of regulations and policies on information security and cybersecurity, which are posted on our OA system and can be accessed by our employees at any time.

The Company has also formulated a privacy policy for the e-commerce applet of the Tissue Business Unit (TBU), conducted special audits for TBU and its e-commerce platform, and regularly commissioned external consultancies to help us apply for the compliance certification for national information security protection of e-commerce platforms to ensure the

compliance and security of the e-commerce platform. In 2022, our e-commerce system has passed the national information security protection level III certification.

In 2022, we focused our information security efforts on infrastructure, data leakage prevention, and information security governance. There was no incident of privacy leaks or cybersecurity incidents throughout the year.

The Company conducts information security training activities for all employees every month through online enterprise WeChat postings, WeChat mini-game push, posters, and phishing email testing, in order to enhance employees' awareness of information security. The Company has

also set up a dedicated email address for employees to report suspicious information security issues to relevant IT departments. In 2022, the Company conducted a total of three in-person executive training sessions and 14 new employee training sessions on information security.

In the future, the Company will strengthen information security risk assessment and advisory services for new technologies that may be used in the process of digital and intelligent transformation, further enhancing our information security governance capabilities and fully ensuring the information security of the newly built infrastructure.

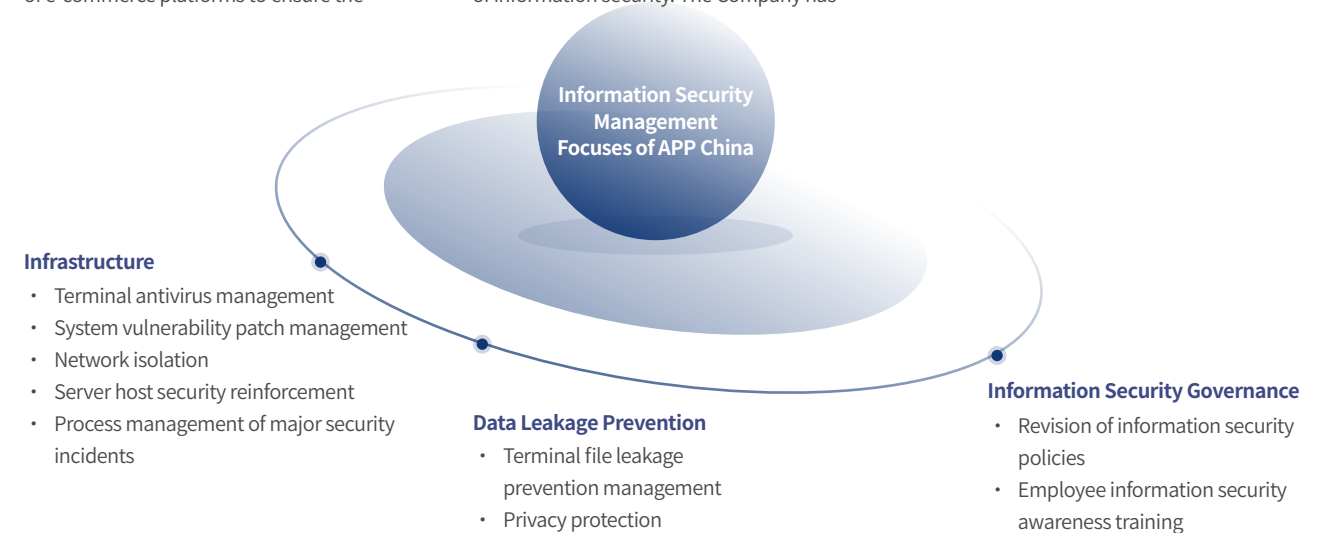



## Business Integrity and Ethics

### Our Commitment:

APP China is committed to business integrity. The Company continuously implements anti-corruption and anti-fraud systems and campaigns, optimizes its disciplinary and prevention systems for business fraud, and makes unremitting efforts to build a good business integrity ecology.

### Our Progress:

Hosted **29** training sessions related to integrity, and **100%** of our employees had received trainings on business ethics compliance and integrity culture

Launched "Sunshine Integrity Month" activities for **five** consecutive years, cultivating a strong integrity culture

Percentage of suppliers to whom our anti-corruption policies had been communicated: **100%**

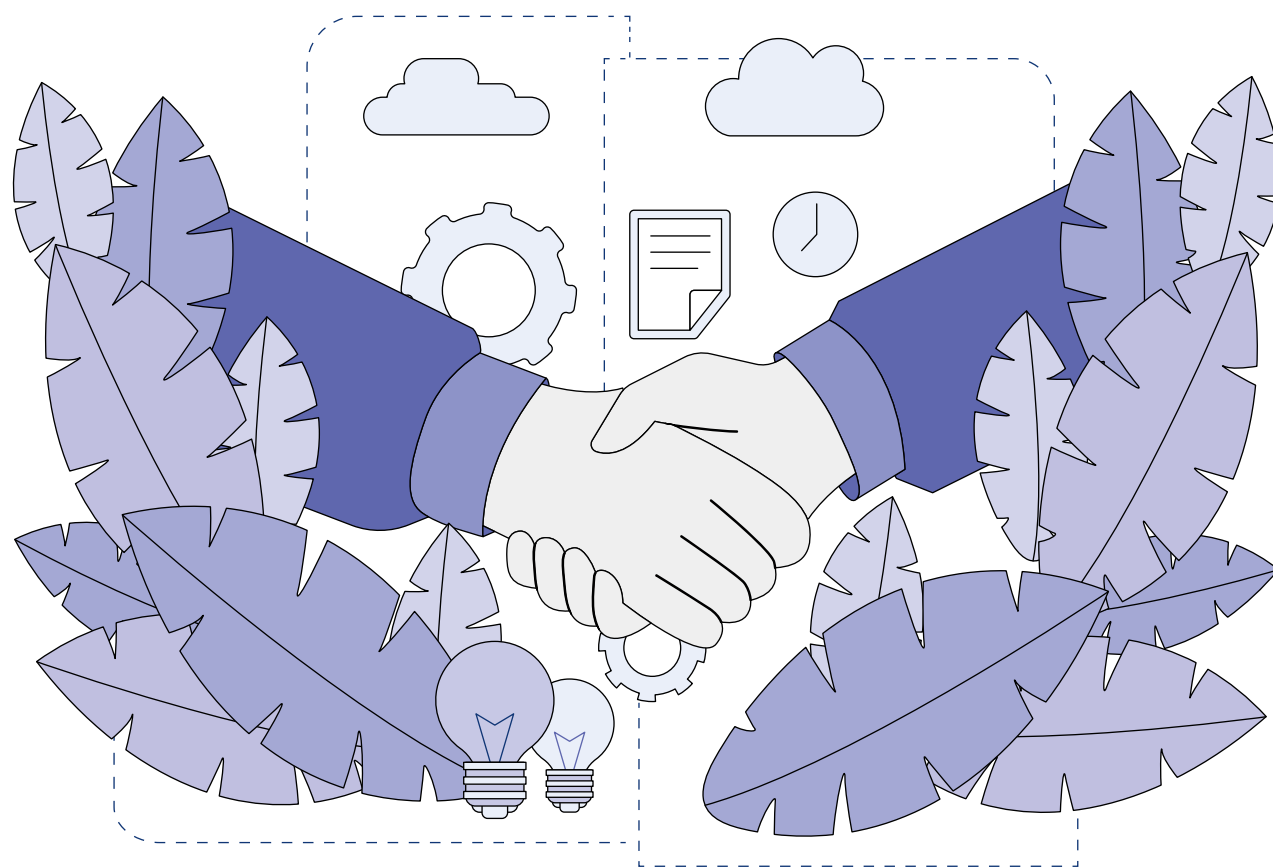

## Integrity and Compliance Management

APP China is committed to the set of moral values built on the cornerstones of "Integrity and Commitment", and has formulated the APP China Integrity Management Framework in accordance with the ISO37001 anti-bribery management system, ensuring the sustainable development of the Company with a top-down integrity

management system. Guided by the APP China Integrity Management Framework, we apply the concept of compliance to all levels of employees, and actively involve all employees as well as suppliers to participate in integrity and compliance management and practices. We have established the Corporate Risk and Integrity Department as the responsible

department for the Company's integrity and compliance management. It collaborates with other departments to plan, supervise, and implement specific integrity and compliance initiatives, forming a well-defined compliance management mechanism with clear accountabilities.

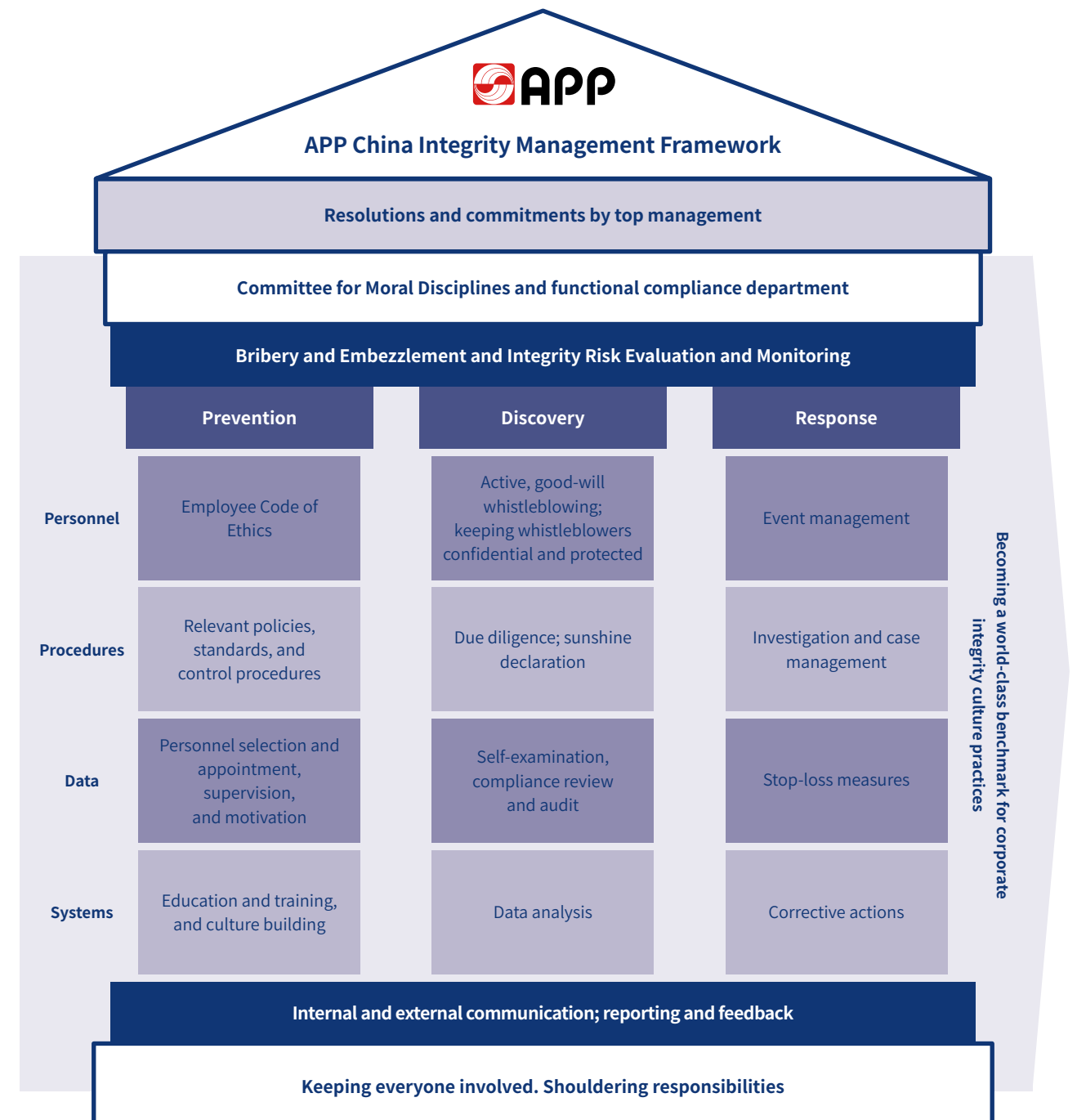

The Company has put forward clear requirements for employees' integrity and compliance behavior in the *Employee Handbook* and has formulated a number of integrity and compliance management policies, such as the *APP China Employee Code of Ethics and Integrity* and the *Provisions for Prohibition of Gifts and Hospitality*. Over the years, the Company has actively implemented the *Whistleblowing Operation Management Measures* and other reward policies to encourage employees, business partners, and other stakeholders to report illegal activities and violations within the Company. The Corporate Risk and Integrity Department and the Internal Audit Department will follow up on the whistleblowing information to ensure that it is appropriately handled while strictly ensuring the confidentiality of the

whistleblower's identity information. We maintain a "zero-tolerance" stance on any behavior that violates professional ethics and principles of integrity, and are committed to handle all illegal or non-compliant behaviors by internal personnel strictly and impartially.

In order to address potential fraud risks, we have established a "Three-line of Defense" system consisting of relevant BUs/ operational departments, internal control functional departments, and the Audit Department, and the Corporate Risk and Integrity Department, to achieve a standardized anti-fraud mechanism. APP China implements and constantly communicates the *Encouraging Reports of Fraud Within the Group and the Reward Plan* to the employees, suppliers, and business

partners. We do so to demonstrate our zero-tolerance stance on fraudulent behavior and support for the reporting of violations in the workplace. As the main responsibility department, the Corporate Risk and Integrity Department has a dedicated anti-fraud investigation team, which is responsible for handling received clues and whistleblowing complaints, and is authorized to conduct investigations independently without interference.

Regarding supplier integrity and compliance management, APP China formulated the *Sinar Mas Supplier/Partner Pledge on Business Compliance and Integrity*, which stipulates the code of conduct for supplier's integrity operation and is accessible in our online supplier management system. All suppliers are required to download and sign it.

## Building a Culture of Integrity

APP China continuously promotes the construction of a culture of integrity, and regularly conducts various training and cultural activities to promote integrity and compliance. In 2022, we continued to engage all employees with a variety of activities,

including training, lectures, thematic learning, online quizzes, brochures, and posters, in the advocacy of ethical standards as set out in the *APP China Employee Code of Ethics*, the *Integrity and the Provisions for Prohibition of Gifts and Hospitality*, and

other relevant policies, aiming to enhance employees' awareness of integrity and compliance and ensure that they practice integrity and compliance in their daily work.

### APP China Integrity and Compliance Whistleblowing Channels



Email:  
GRW@app.com.cn



Phone:  
021-22839763

### APP China Whistleblowing Mechanism

#### Scope of Whistleblowing

- Business related illegal activities or violations
- Violations of the Employee Codes of Conduct of the Company
- Theft/encroachment/misappropriation of corporate assets
- Violation of company policy or integrity principles
- Intentionally damage the reputation of the Company
- Workplace violence
- Major crisis
- Abuse of power
- Corruption/bribery (accepting/giving bribery)
- Leakage of major business secrets or information security incidents
- Conflict of Interest (external and internal)

#### Principles of Whistleblowing

- In good faith and with honesty
- Strict confidentiality
- Real-name whistleblowing is preferred, while anonymous whistleblowing is acceptable



#### Reward for Whistleblowers

- Internal whistleblowers: Bonuses, rewards and credits
- External whistleblowers: Bonuses, Channel rewards

### Sunshine Integrity Month in the Digital Age

In October 2022, APP China organized its annual "Sunshine Integrity Month" event with the theme of "Digital age - Integrity with Digitalization". A series of activities were organized during this four-week period, including the company-wide Integrity Pledge, reporting of conflicts of interest, and integrity examinations, etc. We invited an external expert on digitalization to give a thematic lecture on "Data Governance Empowering Digital Trust". By interpreting the importance of digital trust in data governance and speaking on how to support our digitalization with integrity and compliance, the lecture played an active role in supporting the healthy

development of our digital and intelligent transformation by helping enhance employees' understanding of digital and intelligent transformation from the perspective of integrity and compliance, aiming to promote the healthy development of digital and intelligent transformation. In addition, we also organized integrity-themed training for managers, analyzing the causes behind fraudulent behaviors and emphasizing the importance of integrity and the Company's values of integrity and self-discipline to employees through short videos, case studies, and other forms.



2022 "Sunshine Integrity Month" event



APP China senior management took the Integrity Pledge



Employees participated in integrity advocacy lectures

### Integrity Monthly Introduced Whistleblowing Channels

APP China launched the monthly internal publication, the *Integrity Monthly*, with the goal of continuously promoting and maintaining the integrity culture and business ethics of the Company, and jointly building a transparent and harmonious development environment for the Company. The Company publicized the whistleblowing channels in the monthly publication, and encouraged employees to report any

corruption, illegal or immoral behavior they came across, so as to help the Company identify problems in terms of integrity and ethics. Meanwhile, the *Integrity Monthly* also shared typical cases to help employees better understand the importance of whistleblowing for the Company's healthy development.



# Supply Chain Management

## Our Commitment:

APP China strives to build a transparent and fair supply chain ecosystem by continuously optimizing a supplier management mechanism, strictly managing supplier approval, and applying digital and intelligent technology to supplier management processes. We also actively promote responsible procurement and are committed to continuously increase the proportion of sustainable raw material procurement.

## Our Progress:

Required a mandatory due diligence process for all suppliers to ensure effective assessment and management of supplier risks

Proportion of wood chips with forest certification in total wood chips procurement: **18.88%**

Proportion of wood pulp with forest certification in total wood pulp procurement: **20.55%**

The main supplier categories of APP China include raw materials, energy, technical services, equipment manufacturing, logistics, and engineering and construction. We continuously optimize the supplier due diligence mechanism. With the support

of the online lean management system launched during the year, we have further improved the efficiency and accuracy of supplier risk assessment. Meanwhile, we have established a supplier performance evaluation data cockpit, which reviews

and evaluates supplier performance with application modules such as market intelligence, macro trends, historical data verification, and online analysis models, etc.

### Supplier Approval

- Supplier risk assessment comprehensively considers the financial status, credit profile, fraud record, legal risk, information security, and customer complaint system, etc. of suppliers. Specific vendors such as wood chips and energy suppliers are required to provide proof of third-party certification regarding their health, safety, and environmental protection performance. Suppliers are categorized as low-, medium-, and high-risk.
- Suppliers are required to sign the *Sinar Mas Supplier/Partner Pledge on Business Compliance and Integrity* and the *Corporate Social Responsibility Statement and Pledge*, as well as abide by the integrity and compliance management standards of APP China in their business conducts.

### Supplier Communication and Evaluation

- Suppliers are subject to ongoing risk monitoring, and due diligence assessments are reviewed at random intervals.
- An effective supplier communication mechanism shall be set up to quickly resolve various issues during cooperation to ensure consistent supply of quality products and services.
- Suppliers are classified based on their respective category and evaluation results, and those who fail to meet our requirements for a long time will be removed from our supplier list.

## APP China's Requirements for Pulp and Wood Fiber Suppliers

- Suppliers are required to maintain valid records to demonstrate the origin of the source of raw materials (e.g., plantation), and to be able to demonstrate in general how the suppliers of wood fiber obtained their raw materials.
- Suppliers and their upstream suppliers must comply with the laws and regulations of the countries in which they operate, including laws and regulations on environmental protection.
- Suppliers shall guarantee that all wood chips come from plantation forests.
- Suppliers shall take proactive actions to improve their own sustainability management mechanisms, including strengthening the procurement of raw materials from plantation forests.
- Suppliers shall comply with the Responsible Fiber Procurement & Processing Policy (RFPPP) of APP China's pulp and paper businesses, guaranteeing to provide:
  - only timber that has been properly inspected and certified as legally sourced and traced through the chain of custody;
  - no timber harvested in violation of tradition and civil rights;
  - protection of HCV through appropriate forest management activities in source forests of timber where HCV forests are identified;
  - only waste and wood residues that comply with national regulations and are not on the list of regulated species of the International Union for Conservation of Nature (IUCN) and the *Convention on International Trade in Endangered Species of Wild Fauna and Flora* (CITES) Appendix I;
  - no genetically modified trees for reforestation unless it is assessed as in compliance with best-practice standards; and
  - timber harvested in compliance with the Fundamental Conventions of the International Labour Organization (ILO).

In 2022, we focused on increasing the procurement of wood pulp with forest certification. We procured a total of 1,547,188.90 tons of certified wood pulp and 2,625,433.95 tons of certified wood chips, accounting for 20.55% and 18.88% of total wood pulp and wood chips procurements respectively.

Proportion of Wood Chips Sourced from Certified Forests (%)

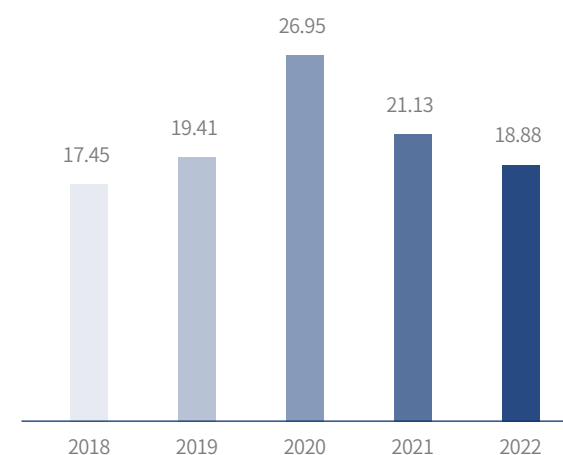

Proportion of Wood Pulp Sourced from Certified Forests (%)

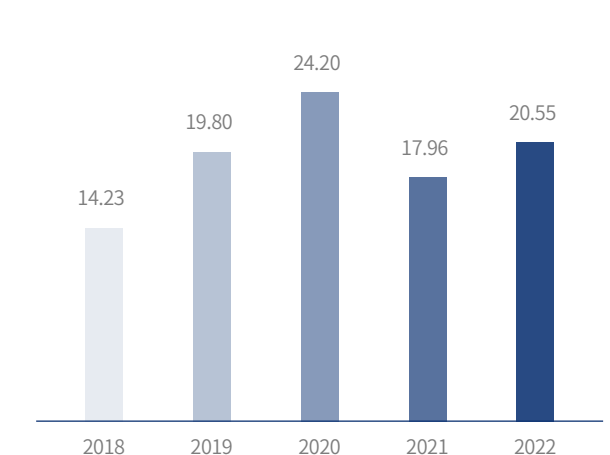

# Performance in Numbers

## Environmental Performance

### Energy\*

Indicator	Unit	2022	2021	2020
Coal	ton	3,533,945.33	3,622,348.26	4,692,593.29
Gasoline	ton	529.62	408.27	382.15
Diesel	ton	3,732.87	3,522.56	4,721.00
Fuel oil	ton	1,651.06	1,146.27	0.00
Natural gas	10,000 cubic meters	23,070.74	22,797.08	186,805.47
LPG	ton	8,976.29	7,179.45	3,072.64
Kerosene	ton	0.66	0.65	0.44
Purchased electricity	10,000 kWh	427,144.95	376,627.71	111,190.99
Purchased steam	GJ	15,460,124.74	12,106,028.74	1,502,787.00
Black liquor from pulp	ton	2,978,895.18	2,796,688.29	2,760,861.37
Other biomass fuels	ton	537,774.95	387,104.53	331,960.35
Solar power generation	10,000 kWh	3,102.42	2,440.66	2,514.60
Purchased green electricity	10,000 kWh	21,122.00	0	0

\*Not including the data of Rudong Base.

### Water resources and wastewater\*

Indicator	Unit	2022	2021	2020
Total water withdrawal**	ton	140,426,381.96	125,567,722.20	120,215,643
Total wastewater discharge***	ton	109,903,311.37	101,907,671.22	89,726,593
Wastewater discharge per ton of paper produced	ton	5.79	5.88	6.20
Wastewater discharge per ton of pulp produced	ton	9.60	12.46	12.50
COD emissions per ton of paper produced	kg	0.24	0.24	0.22
COD emissions per ton of pulp produced	kg	0.60	0.86	0.85

\*Not including data from APP China Headquarters and Rudong Base. Not including data from APP China Forestry except for the indicator of total water withdrawal.

\*\*98.54% came from surface water, 1.45% from third-party facilities, and 0.01% from ground water.

\*\*\*In 2022, there were zero incidents of major water body pollution at APP China.

Mill*	Annual average discharge concentration (mg/L)				
	COD	NH <sub>3</sub> -N	Total Phosphorous (TS)	Total Nitrogen(TN)	Suspended Solids
Gold East Paper	46.94	1.02	0.19	3.59	7.67
Hainan Jinhai Pulp & Paper	59.39	0.775	0.026	3.69	16.5
Ningbo Asia	46.85	0.94	0.14	2.55	15
Guangxi Jingui Pulp & Paper	48.88	0.84	0.068	3.31	4.8
Shandong Base of Bohui Paper	26.5	0.435	0.0401	3.72	-
Jiangsu Base of Bohui Paper	32.88	1.85	0.03	5.42	-

\* Wastewater discharged from Hainan Gold Hongye and Hainan Gold Shengpu was treated by Hainan Jinhai Pulp & Paper. The annual average pollutant discharge concentration data for each mill were below the requirements of the *Discharge Standard of Water Pollutants for Pulp and Paper Industry* (GB 3544-2008).

### Water reuse

Mill	Amount of reused water (ton)		
	2022	2021	2020
Gold East Paper	650,109,600	658,752,000	594,104,400
Hainan Jinhai Pulp & Paper	974,001,791	985,949,728	1,022,668,368
Ningbo Asia	245,318,915	230,884,979	234,576,459
Guangxi Jingui Pulp & Paper	430,151,971	340,441,483	311,807,317
Hainan Gold Hongye	66,501,000	68,373,110	69,750,625
Hainan Gold Shengpu	62,574,421	60,042,237	59,399,375

### Air pollutant emissions\*

Indicator	Unit	2022	2021	2020
Total SO <sub>2</sub> emissions	ton	688.82	550.15	404.50
Total NO <sub>x</sub> emissions	ton	4,243.02	3,995.42	4,145.61
Total soot emissions	ton	342.10	292.95	305.06
Total VOCs emissions	ton	0.04	0.14	-

\*Not including the data of APP China Forestry and Rudong Base.



Mill	Exhaust gas emissions (ton)			
	SO <sub>2</sub>	NO <sub>x</sub>	Soot	Volatile Organic Compounds (VOCs)
Gold East Paper	99.82	267.1	15.38	0
Hainan Jinhai Pulp & Paper*	182	2,586	197	0
Ningbo Asia	201.55	662.09	16.62	0
Guangxi Jingui Pulp & Paper	205.35	703.45	107.46	0
Bohui Paper	0.103	24.38	5.644	0.036

\*The data of Hainan Jinhai Pulp & Paper include those of Hainan Gold Hongye and Hainan Gold Shengpu.

## Waste\*

Indicator	Unit	2022	2021	2020
Non-hazardous waste generated	ton	2,199,475.04	1,933,954.95	1,772,130.11
Non-hazardous waste disposed of	ton	2,202,827.72	2,017,693.61	1,914,695.06
Recycling and reuse	ton	353,504.67	378,796.61	717,315.56
Onsite	ton	106,417.74	109,014.00	-
Offsite	ton	247,086.94	269,782.61	-
Incineration	ton	856,288.15	779,631.70	485,644.50
With energy recovery	ton	848,707.19	772,455.80	-
Without energy recovery	ton	7,580.96	7,175.90	-
Selling to external parties for reuse	ton	986,722.60	851,379.42	705,781.84
Centralized treatment by local sanitation departments	ton	5,986.41	6,570.00	5,293.00
Hazardous waste generated	ton	1,203.76	2,096.41	759.77
Hazardous waste disposed of	ton	1,242.56	2,098.16	844.36

\*Not including the data of APP China Forestry and Rudong Base.

## Environmental investment

Indicator	Unit	2022	2021	2020
Environmental investment	RMB10,000	101,174.12	103,069.13	73,084.31

## Environmental compliance

Indicator	Unit	2022	2021	2020
Environmental fines	RMB10,000	0	0	0

## Social performance

### Employment\*

Indicator	Unit	2022	2021	2020
Employees directly and indirectly employed	person	21,361	19,428	19,027
Employees directly employed	person	20,568	18,486	17,455
Male employees directly employed	person	15,900	14,184	12,926
Female employees directly employed	person	4,668	4,302	4,529
Employees with ethnic minority background	person	1,039	927	-
Employees from Mainland China	person	20,440	18,352	-
Employees from Hong Kong, Macao and Taiwan	person	92	94	-
Employees from abroad	person	36	40	-
Employees with disabilities	person	73	69	-
Employees indirectly employed	person	793	942	1,572
Male employees indirectly employed	person	651	770	1,102
Female employees indirectly employed	person	142	172	470
New employees	person	5,763	4,848	1,507
New male employees	person	4,621	3,742	1,165
New female employees	person	1,142	1,106	342
Employee turnover	person	3,577	2,514	1,962
Male employees who voluntarily resigned	person	2,246	1,545	911
Female employees who voluntarily resigned	person	564	320	366
Male employees who were involuntarily terminated**	person	492	433	479
Female employees who were involuntarily terminated**	person	99	92	151
Male employees who retired	person	65	30	10
Female employees who retired	person	111	94	45

\*Employee-related data is calculated from statistical data within the scope of the report.

\*\*The reasons for involuntary termination mainly include firing, non-renewal, negotiated termination, transfer to a sister mill, and death.

### Employee turnover rate

Indicator	Unit	2022	2021	2020
Employee turnover rate	%	14.81	11.97	10.10
Male employee turnover rate	%	14.99	12.40	9.77
Female employee turnover rate	%	14.22	10.52	11.04
Turnover rate of employees aged 30 and below	%	29.23	21.07	-
Turnover rate of employees aged between 31 and 50	%	9.32	8.34	-
Turnover rate of employees aged 51 and above	%	11.28	16.56	-

## Employee retention after maternity/paternity leave

Indicator	Unit	2022	2021	2020
Female employees who took maternity leave	person	155	124	239
Female employees who returned to work after maternity leave	person	141	114	212
Female employees who resigned after maternity leave	person	12	6	20
Male employees who took paternity leave	person	400	338	437
Male employees who returned to work after paternity leave	person	383	323	418
Male employees who resigned after paternity leave	person	14	5	5

## Employee composition by level

Indicator	Unit	2022	2021	2020
Percentage of senior-level managers	%	0.95	0.99	1
Percentage of middle-level managers	%	9.70	8.80	11
Percentage of line-level employees	%	89.35	90.21	88

## Employee composition by gender

Indicator	Unit	2022	2021	2020
Percentage of female employees	%	22.70	23.27	25.95
Number of female employees in management	person	412	337	571
Percentage of female employees in management	%	18.80	18.62	27.29

## Employee composition by age

Indicator	Unit	2022	2021	2020
Percentage of employees aged 30 and below	%	22.21	20.12	14.13
Percentage of employees aged between 31 and 50	%	68.65	70.93	81.05
Percentage of employees aged 51 and above	%	9.14	8.94	4.82

## Employee training

Indicator	Unit	2022	2021	2020
Total training investment	RMB10,000	387.76	562.16	391.81
Total employee training time	hour	1,052,512.80	753,012	619,287
Number of employees who participated in company-paid diploma programs	person	79	35	11
Total investment in company-paid diploma programs for employees	RMB10,000	2.92	2.55	3.30

Indicator	Unit	2022	2021	2020
Average training time for senior management	hour	32.71	37.99	11.23
Average training time for mid-level management	hour	40.44	31.62	17.54
Average training time for line-level employees	hour	41.40	41.65	35.34

## Occupational health and safety\*

Indicator	Unit	2022	2021	2020
Employee safety training time	hour	631,233.50	450,918.00	300,011.50
Total investment in protective gears	RMB10,000	1,055.92	922.51	634.58
Work-related injuries of employees	person-time	51	44	45
Work-related fatalities of employees	person	1	0	0
Total lost worktime rate of employees**	/	1,307.74	2,234.87	924.79
Lost time injury frequency rate of employees***	/	1.25	-	-
Work-related injuries of contractors	person-time	4	5	3
Work-related fatalities of contractors	person	1	-	-
Total lost worktime rate of contractors**	/	159.33	-	-
Lost time injury frequency rate of contractors***	/	0.14	-	-

\* Not including the data of Rudong Base.

\*\* Total lost worktime rate = (Total lost hours/Total hours worked in the reporting period) × 1,000,000

\*\*\* Lost time injury frequency rate = (Number of lost time injuries/Total hours worked in the reporting period) × 1,000,000

## Indirect economic impact

Indicator	Unit	2022	2021	2020
Employee volunteer hours	hour	30,348	16,532	15,544
Donations	RMB10,000	15,727	4,676	14,879

# Economic and Governance Performance

## Economic performance

Indicator	Unit	2022	2021	2020
Total assets	RMB100 million	2,445	2,465	2,480
Total taxes paid	RMB100 million	51	47	35
Sales revenue	RMB100 million	943	973	738
Total profit	RMB100 million	81	84	73
Net profit	RMB100 million	61	64	62



## Places of origin for APP China's pulp procurement\*

Region	2022	2021	2020
China	45.03%	39.89%	43.25%
Other Asian regions	31.27%	33.49%	28.69%
North America	8.14%	12.88%	18.49%
South America	9.55%	5.64%	4.23%
Europe	6.01%	7.96%	5.01%
Oceania	0%	0.14%	0.32%

\*The changes in the proportion of each origin of procurement are mainly determined by product quality and relevant market price.

## Materials

Indicator	Unit	2022	2021	2020
Total amount of wood chips purchased	10,000 tons	1,390.55	1,129.64	874.50
Amount of certified wood chips*	10,000 tons	262.54	238.69	235.67
Proportion of certified wood chips	%	18.88	21.13	26.95
Total amount of wood pulp purchased	10,000 tons	752.82	692.10	626.41
Amount of certified wood pulp*	10,000 tons	154.72	124.30	151.60
Proportion of certified wood pulp	%	20.55	17.96	24.20
Total amount of waste paper purchased	10,000 tons	52.97	52.82	10.39

\*Including CFCC/PEFC Certification and FSC Certification.

## Anti-corruption

Indicator	Unit	2022	2021	2020
Number of governance agency members reached by anti-corruption policies and procedures	person	20	14	15
Percentage of governance agency members reached by anti-corruption policies and procedures	%	100	100	100
Number of governance agency members receiving anti-corruption training	person	20	14	15
Percentage of governance agency members receiving anti-corruption training	%	100	100	100
Number of senior-level managers receiving anti-corruption training	person	196	183	160
Percentage of senior-level managers receiving anti-corruption training	%	100	100	100
Number of middle-level managers receiving anti-corruption training	person	1,995	1,627	1,917
Percentage of middle-level managers receiving anti-corruption training	%	100	100	100
Number of line-level employees receiving anti-corruption training	person	18,377	16,676	15,363
Percentage of line-level employees receiving anti-corruption training	%	100	100	100
Number of incidents of termination or non-renewal of contracts with suppliers due to corruption*	case	19	12	-

\*In advocacy for a culture of integrity and compliance, APP China requests all suppliers to sign the *Sinar Mas Supplier/Partner Pledge on Business Compliance and Integrity* and the *Corporate Social Responsibility Statement and Pledge*. The percentage of suppliers to whom anti-corruption policies have been communicated to is 100%.

## Assurance Statement

### Independent Verification Statement



To the management and stakeholders of APP China,

TÜV SÜD Certification and Testing (China) Co., Ltd. Shanghai Branch (hereinafter referred to as "TÜV SÜD") has been engaged by Sinar Mas Paper (China) Investment Co., Ltd. and the group of companies under its direct investment in China (herein referred to as "APP China" or "the Company") to perform an independent third-party verification on APP China 2022 Sustainability/ESG Report (hereinafter referred to as "the Report"). During this verification, TÜV SÜD's verification team strictly abided by the contract signed with APP China and provided verification regarding the Report in accordance with the provisions agreed by both parties and within the authorized scope stipulated in the contract.

This Independent Verification Statement is based on the data and information collected by APP China and provided to TÜV SÜD. The scope of verification is limited to the given information. APP China shall be held accountable for authenticity and completeness of the provided data and information.

#### Scope of Verification

Time frame of this verification:

- The Report contains the data disclosed by APP China during the reporting period from January 1st, 2022 to December 31st, 2022, including economic, environmental and social information and data, methods for management of substantial issues, actions/measures and the Company's sustainability performance during the reporting period.

Physical boundary of this verification:

- The verification took sampling way to carry out the on-site work, the verification location is detailed as follows:

Scope of the Report	Verification Location
APP China Headquarters	65F, Sinar Mas Plaza, No.501 East Daming Road, Hongkou District, Shanghai, China
Gold Hongye Paper (Nantong) Co., Ltd.	No.1 Lingang Dadao, Changsha Town, Rudong County, Nantong City, Jiangsu Province, China
APP China Forestry Business – Hainan Office	Online Verification
APP China Forestry Business - Lancang Sub-BU	Lancang Forestry, Yunnan Province
Hainan Gold Hongye Paper Co., Ltd.	D12 District, Yangpu Free Trade Port Zone, Haikou City, Hainan Province, China
Hainan Jinhai Pulp & Paper Co., Ltd.	
Hainan Gold Shengpu Paper Co., Ltd.	
Gold East Paper (Jiangsu) Co., Ltd.	Not in the scope of this verification sample
Ningbo Asia Pulp & Paper Co., Ltd.	Not in the scope of this verification sample
Guangxi Jingui Pulp & Paper Co., Ltd.	Not in the scope of this verification sample
Gold Hongye Paper Group Co., Ltd.	Not in the scope of this verification sample
Shandong Bohui Paper Co., Ltd.	Not in the scope of this verification sample
APP China Forestry Business - other Sub-BU	Not in the scope of this verification sample

Scope of data and information for the verification:

- The scope of verification is limited to the data and information of APP China and Plants/Production sites under its operational control covered by the Report.

The following information and data are beyond the scope of this verification:

- Any information and contents beyond the reporting period of this Report; and
- The Data and information of APP China's suppliers, partners and other third parties; and
- The financial data and information disclosed in this Report that have been audited by an independent third party are not verified again herein.

ID: 252713 Revision: 0 - released Effective: 25 Aug 2023

## Independent Verification Statement



## Independent Verification Statement



### Limitations

- The verification process is conducted in the above scope and place. Sampling and verification are adopted for the data and information in the Report by TÜV SÜD, and only the stakeholders within the organization are interviewed; and
- The Company's standpoint, opinions, forward-looking statements and predictive information as well as the historical data and information before January 1<sup>st</sup>, 2022 are beyond the scope of this verification.

### Basis for the Verification

This verification process was conducted by TÜV SÜD's expert team with extensive experience in the economic, social, environmental and other relevant areas and drew the "limited assurance" conclusions thereof. The verification referred to the following standards:

- AA1000AS v3, Type 1 Engagement and Moderate Level of Assurance
- TÜV SÜD Procedure of Verification on Sustainability Report

In order to perform adequate verification in accordance with the contract and provide reasonable verification for the conclusions, the verification team conducted the following activities:

- Preliminary background investigation of the relevant information before the verification; and
- Confirmation of the presence of the topics with high level of materiality and performance in the Report; and
- On-site review of all supporting documents, data and other information provided by APP China; tracing and verification of key performance information; and
- Special interview with the representative of APP China's management; interviews with the employees related to collection, compilation and reporting of the disclosed information; and
- Other procedures deemed necessary by the verification team.

### Verification Conclusions

According to the verification, we believe the Report prepared by APP China adheres to the requirement of AA1000AS v3.

The verification team has drawn the following conclusions on this Report:

<b>Inclusivity</b>	APP China has fully identified the internal and external stakeholders of the organization, such as employees, customers and consumers, suppliers/contractors, banks, government agencies, community representatives, industry associations, professional bodies, NGOs, media, etc., and has established a stakeholder communication mechanism to regularly collect the real demands of stakeholders.
<b>Materiality</b>	APP China has established a prioritization process for material topics, identified sustainability topics that are highly relevant to the industry and prioritized the topics, disclosed strategies, management actions and performance data in the company's sustainability management and operations process, and the report content is substantive overall, with room for improvement in the material topics of individual topics.
<b>Responsiveness</b>	APP China has clearly disclosed the management methods and performance of major issues in the areas of occupational health and safety, product quality and safety, water management and air pollutant emissions, and has established various stakeholder communication mechanisms to fully respond to stakeholders' demands and expectations.
<b>Impact</b>	APP China has identified the core impact areas: energy saving and emission reduction, forest protection, and community development. In this way, APP China has built a 2030 sustainable development strategy framework and

ID: 252713 Revision: 0 - released Effective: 25 Aug 2023

ID: 252713 Revision: 0 - released Effective: 25 Aug 2023

formulated a management system of "three lines of defense for internal control" to continuously strengthen risk identification and management and to build a solid foundation for sound and sustainable operation of the company.

After verification on a sample basis, we believe that the following data disclosed in the report for the year 2022 are true and reliable for use by interested parties:

Environmental	Social	Economic
<ul style="list-style-type: none"> <li>■ Energy consumption data</li> <li>■ Water Resource and wastewater data:                             <ul style="list-style-type: none"> <li>• Total water withdrawals</li> <li>• Wastewater Discharge</li> <li>• Wastewater discharge per unit of product</li> <li>• COD discharge per unit of product</li> <li>• Average annual discharge concentration of water pollutants by plant</li> <li>• Total amount of recycled water used in each plant</li> </ul> </li> <li>■ Air pollutant emission data</li> <li>■ Waste data:                             <ul style="list-style-type: none"> <li>• Amount of general waste generated and disposed of</li> <li>• General waste recycling volume, incineration volume, export comprehensive utilisation volume and classification details</li> <li>• Hazardous waste generation and disposal volume</li> </ul> </li> <li>■ Environmental protection investment</li> <li>■ Environment compliance (penalty situation)</li> </ul>	<ul style="list-style-type: none"> <li>■ Employees:                             <ul style="list-style-type: none"> <li>• Employment Status</li> <li>• Employee turnover rate</li> <li>• Employee retention after maternity/paternity leave</li> <li>• Percentage of employees at each level</li> <li>• Employee gender ratio</li> <li>• Proportion of employees by age group</li> <li>• Employee Training</li> </ul> </li> <li>■ Occupational Health and Safety:                             <ul style="list-style-type: none"> <li>• Employee safety training time</li> <li>• Amount of investment in protective equipment</li> <li>• Number of work-related injuries to employees</li> <li>• Number of work-related employee fatalities</li> <li>• Number of hours lost per million working hours</li> <li>• Number of hours per million lost accident rate</li> <li>• Number of contractor injuries</li> <li>• Number of contractor work-related fatalities</li> <li>• Contractor million man-hours lost work rate</li> <li>• Contractor million man-hours lost time accident rate</li> </ul> </li> <li>■ Indirect economic impact:                             <ul style="list-style-type: none"> <li>• Volunteer hours devoted</li> <li>• Amount of donations to the public</li> </ul> </li> </ul>	<ul style="list-style-type: none"> <li>■ Economic Performance:                             <ul style="list-style-type: none"> <li>• Total assets</li> <li>• Total taxes and fees paid</li> <li>• Operating income</li> <li>• Total profit</li> <li>• Net profit</li> </ul> </li> <li>■ Pulp procurement source distribution</li> <li>■ Material indicators:                             <ul style="list-style-type: none"> <li>• Total amount of wood chips purchased and their certification</li> <li>• Total amount of wood pulp purchased and its certification</li> <li>• Raw wastepaper purchases</li> </ul> </li> <li>■ Anti-corruption status (communication of policies and procedures, training, termination of cooperation due to corruption)</li> <li>■ R&amp;D investment</li> <li>■ Number of patents applied for</li> </ul>

### Recommendations on Continuous Improvement

- It is recommended that the company systematically conducts energy management and greenhouse gas (GHG) inventory, making sure that the GHG reporting cycle is aligned with this Report, and that GHG emission data is tracked and managed to disclose trends in total GHG emission values/intensity to stakeholders.

### Statement on Independence and Verification Capability

TÜV SÜD is a trusted partner of choice for safety, security and sustainability solutions. It specialises in testing, certification, auditing and advisory



## Independent Verification Statement



services. Since 1866, TÜV SÜD has remained committed to its purpose of enabling progress by protecting people, the environment and assets from technology-related risks. Today, TÜV SÜD is present in over 1,000 locations worldwide with its headquarters in Munich, Germany. TÜV SÜD has been committed to sustainable development and actively promotes environmental protection related projects. Over the years, TÜV SÜD has been actively expanding its performance in energy management, renewable resources, and electric automobiles, etc., helping its customers meet sustainable development needs.

TÜV SÜD Certification and Testing (China) Co., Ltd. Shanghai Branch is one of TÜV SÜD's global branches and has an expert team whose members have professional background and rich industrial experiences.

TÜV SÜD and APP China are two entities independent of each other and both TÜV SÜD and APP China and their branches or stakeholders have no conflict of interest. No member of the verification team has business relationship with the Company. The verification is completely neutral. All the data and information in the Report are provided by APP China. TÜV SÜD has not been involved in preparation and drafting of the Report, except for the verification itself and issuance of the verification statement.

**Signature:**

**On Behalf of TÜV SÜD Certification and Testing (China) Co., Ltd. Shanghai Branch**



Zhu Wenjun  
TÜV SÜD Sustainability Authorized Signatory Officer  
Sep 22<sup>nd</sup>, 2023  
Shanghai, China

Note: In case of any inconsistency or discrepancy, the simplified Chinese version "Independent Verification Statement CN" of this verification statement shall prevail, while the English translation is used for reference only.

ID: 252713 Revision: 0 - released Effective: 25 Aug 2023

TUV SUD Certification and Testing (China) Co., Ltd. Shanghai Branch  
No.151 Heng Tong Road, Shanghai 200070

Page 4 of 4  
Tel: +86 21-61410737  
Fax: +86 21-61408600  
Web: <http://www.tuvsud.cn>

## GRI Standards (2021) Content Index

Statement of use	APP China has reported in accordance with the GRI Standards for the period from January 1, 2022 to December 31, 2022.
GRI 1 used	GRI 1: Foundation 2021

GRI Standard	Disclosure	Page Numbers	
GRI 2: General Disclosures 2021	2-1	Organizational details	4; Inside back cover
	2-2	Entities included in the organization's sustainability reporting	Inside back cover
	2-3	Reporting period, frequency and contact point	Inside back cover
	2-4	Restatements of information	Inside back cover
	2-5	External assurance	107-110
	2-6	Activities, value chain and other business relationships	4; 15-17; 98-99; 105
	2-7	Employees	103
	2-8	Workers who are not employees	69; 103
	2-9	Governance structure and composition	5
	2-12	Role of the highest governance body in overseeing the management of impacts	2-3; 30
	2-13	Delegation of responsibility for managing impacts	30
	2-14	Role of the highest governance body in sustainability reporting	Inside back cover
	GRI 3: Material Topics 2021	2-16	Communication of critical concerns
2-17		Collective knowledge of the highest governance body	12-13; 15-17; 30
2-22		Statement on sustainable development strategy	2-3; 12-13
2-23		Policy commitments	14-15; 60-61; 94-97
2-24		Embedding policy commitments	30-31; 61-64; 92-99; 106
2-25		Processes to remediate negative impacts	60-61; 67-70; 95-96
2-26		Mechanisms for seeking advice and raising concerns	60-61; 64; 95-96
2-27		Compliance with laws and regulations	102
2-28		Membership associations	8-11
2-29		Approach to stakeholder engagement	15-19
GRI 201: Economic Performance 2016	3-1	Process to determine material topics	18-19
	3-2	List of material topics	18-19
	3-3	Management of material topics	12-13; 15-19; 30-36; 38-41; 42-99
GRI 203: Indirect Economic Impacts 2016	201-1	Direct economic value generated and distributed	4; 105
	201-2	Financial implications and other risks and opportunities due to climate change	30-36; 50-53
GRI 204: Procurement Practices 2016	203-1	Infrastructure investments and services supported	75-79
	203-2	Significant indirect economic impacts	22-28; 34-36; 53; 71-72; 75-79; 89-91
	204-1	Proportion of spending on local suppliers	98-99; 106

GRI Standard	Disclosure	Page Numbers	
GRI 205: Anti-corruption 2016	205-2	Communication and training about anti-corruption policies and procedures	94-98; 106
	205-3	Confirmed incidents of corruption and actions taken	106
GRI 301: Materials 2016	301-1	Materials used by weight or volume	106
	301-2	Recycled input materials used	106
GRI 302: Energy 2016	302-1	Energy consumption within the organization	50-53; 100
	302-4	Reduction of energy consumption	23-26; 30-36; 51-52
GRI 303: Water and Effluents 2018	303-1	Interactions with water as a shared resource	23-26; 48-49; 54-56
	303-2	Management of water discharge-related impacts	48-49; 54-56
	303-3	Water withdrawal	100-101
	303-4	Water discharge	100-101
	303-5	Water consumption	100-101
GRI 304: Biodiversity 2016	304-1	Operational sites owned, leased, managed in, or adjacent to, protected areas and areas of high biodiversity value outside protected areas	38-41; 47
	304-2	Significant impacts of activities, products and services on biodiversity	38-41; 47
	304-3	Habitats protected or restored	38-41
	304-4	IUCN Red List species and national conservation list species with habitats in areas affected by operations	38-41
GRI 305: Emissions 2016	305-1	Direct (Scope 1) GHG emissions	50-53
	305-2	Energy indirect (Scope 2) GHG emissions	50-53
	305-3	Other indirect (Scope 3) GHG emissions	50-53
	305-5	Reduction of GHG emissions	30-36; 52-53
	305-7	Nitrogen oxides (NO <sub>x</sub> ), sulfur oxides (SO <sub>x</sub> ), and other significant air emissions	56; 101-102
GRI 306: Waste 2020	306-1	Water generation and significant waste-related impacts	57
	306-2	Management of significant waste-related impacts	23-26; 48-49; 57
	306-3	Waste generated	57; 102
	306-4	Waste diverted from disposal	57; 102
	306-5	Waste directed to disposal	57; 102
GRI 308: Supplier Environmental Assessment 2016	308-1	New suppliers that were screened using environmental criteria	98-99
	308-2	Negative environmental impacts in the supply chain and actions taken	98-99
GRI 401: Employment 2016	401-1	New employee hires and employee turnover	103
	401-2	Benefits provided to full-time employees that are not provided to temporary or part-time employees	60-61
	401-3	Parental leave	104
GRI 403: Occupational Health and Safety 2018	403-1	Occupational health and safety management system	65-66; 69-70
	403-2	Hazard identification, risk assessment, and incident investigation	65-66; 68
	403-3	Occupational health services	70
	403-4	Worker participation, consultation, and communication on occupational health and safety	65-70
	403-5	Worker training on occupational health and safety	67-70; 105
	403-6	Promotion of worker health	70

GRI Standard	Disclosure	Page Numbers	
GRI 403: Occupational Health and Safety 2018	403-7	Prevention and mitigation of occupational health and safety impacts directly linked by business relationships	65-70
	403-8	Workers covered by an occupational health and safety management system	65-70
	403-9	Work-related injuries	105
	403-10	Work-related ill health	70; 105
GRI 404: Training and Education 2016	404-1	Average hours of training per year per employee	104-105
	404-2	Programs for upgrading employee skills and transition assistance programs	61-64; 77
GRI 405: Diversity and Equal Opportunity 2016	405-1	Diversity of governance bodies and employees	103; 104
GRI 406: Non-discrimination 2016	406-1	Incidents of discrimination and corrective actions taken	Did not occur
GRI 408: Child Labor 2016	408-1	Operations and suppliers at significant risk for incidents of child labor	Did not occur
GRI 409: Forced or Compulsory Labor 2016	409-1	Operations and suppliers at significant risk for incidents of forced or compulsory labor	Did not occur
GRI 413: Local Communities 2016	413-1	Operations with local community engagement, impact assessments, and development programs	38-41; 44-47; 75-79
	413-2	Operations with significant actual and potential negative impacts on local communities	45-47; 78-79
GRI 414: Supplier Social Assessment 2016	414-1	New suppliers that were screened using social criteria	98-99
	414-2	Negative social impacts in the supply chain and actions taken	98-99; 106
GRI 416: Customer Health and Safety 2016	416-1	Assessment of the health and safety impacts of product and service categories	27-28; 71-74; 89-91
	416-2	Incidents of non-compliance concerning the health and safety impacts of products and services	Did not occur
GRI 417: Marketing and Labeling 2016	417-1	Requirements for product and service information and labeling	14; 34-36; 53; 89-91
GRI 418: Customer Privacy 2016	418-1	Substantiated complaints concerning breaches of customer privacy and losses of customer data	Did not occur



## TCFD Index

TCFD Recommended Disclosures	Page Numbers
<b>Governance: Disclose the company's governance around climate-related risks and opportunities.</b>	
a. Describe the board's oversight of climate-related risks and opportunities.	30
b. Describe management's role in assessing and managing climate-related risks and opportunities.	30
<b>Strategy: Disclose the actual and potential impacts of climate-related risks and opportunities on the company's businesses, strategy, and financial planning where such information is material.</b>	
a. Describe the climate-related risks and opportunities the company has identified over the short, medium, and long term.	22-28; 32-36; 89-91
b. Describe the impact of climate-related risks and opportunities on the company's businesses, strategy, and financial planning.	12-13; 22-28; 31-36; 89-91
c. Describe the resilience of the company's strategy, taking into consideration different climate-related scenarios, including a 2° C or lower scenario.	31
<b>Risk Management: Disclose how the company identifies, assesses, and manages climate-related risks.</b>	
a. Describe the company's processes for identifying and assessing climate-related risks.	30-33
b. Describe the company's processes for managing climate-related risks.	30-33
c. Describe how processes for identifying, assessing, and managing climate-related risks are integrated into the company's overall risk management.	32-33
<b>Metrics and Targets: Disclose the metrics and targets used to access and manage relevant climate-related risks and opportunities where such information is material.</b>	
a. Disclose the metrics used by the company to assess climate-related risks and opportunities in line with its strategy and risk management process.	12-13; 50-53
b. Disclose Scope 1, Scope 2, and, if appropriate, Scope 3 greenhouse gas (GHG) emissions, and the related risks.	50-53
c. Describe the targets used by the company to manage climate-related risks and opportunities and performance against targets.	12-13; 31-36

## UN Global Compact Ten Principles Index

Theme	Principle	Page Numbers
Human Rights	Principle 1: Businesses should support and respect the protection of internationally proclaimed human rights; and	60-61; 65-70; 73-79; 95-96; 98-99
	Principle 2: make sure that they are not complicit in human rights abuses.	60-61; 65-70; 95-96; 98-99
Labor	Principle 3: Businesses should uphold the freedom of association and the effective recognition of the right to collective bargaining;	60-64
	Principle 4: the elimination of all forms of forced and compulsory labor;	60-61; 98-99
	Principle 5: the effective abolition of child labor; and	60-61; 98-99
	Principle 6: the elimination of discrimination in respect of employment and occupation.	60-61
Environment	Principle 7: Businesses should support a precautionary approach to environmental challenges;	30-36; 38-41; 44-57; 89-91
	Principle 8: undertake initiatives to promote greater environmental responsibility; and	30-36; 38-41; 44-57; 89-91
	Principle 9: encourage the development and diffusion of environmentally friendly technologies.	22-28; 48-57; 89-91
Anti-corruption	Principle 10: Businesses should work against corruption in all its forms, including extortion and bribery.	92-98; 106

## About this Report

This is the 16th Sustainability Report issued by Sinar Mas Paper (China) Investment Co., Ltd. and its subsidiaries or other affiliated enterprises (referred to as APP China). The report is released in both Chinese and English. The English report is translated from the Chinese report. If there is any discrepancy between the two reports, the Chinese version shall prevail. The Board of Directors, as the top governance body of APP China, is ultimately responsible for reviewing and approving the information disclosed in this report.

### Reporting Boundary and Scope

The time span of this report is from January 1, 2022 to December 31, 2022. Our last Sustainability Report was released in November 2022. Data in "Company Profile", "Economic performance", "Places of origin for APP China's pulp procurement" and "Materials" relate to Sinar Mas Paper (China) Investment Co., Ltd. and its subsidiaries or other affiliated enterprises. Cases and other data in the report are collected from APP China Headquarters, pulp & paper mills, and APP China Forestry Business Unit, unless otherwise stated.

- APP China Headquarters
- Gold East Paper (Jiangsu) Co., Ltd. (Gold East Paper)
- Hainan Jinhai Pulp & Paper Co., Ltd. (Hainan Jinhai Pulp & Paper)
- Guangxi Jingui Pulp & Paper Co., Ltd. (Guangxi Jingui Pulp & Paper)
- Ningbo Asia Pulp & Paper Co., Ltd. (Ningbo Asia)
- Shandong Bohui Paper Co., Ltd. (Bohui Paper)
- Gold Hongye Paper Group Co., Ltd. (Gold Hongye Paper)
- Gold Hongye Paper (Nantong) Co., Ltd. (Rudong Base)
- Hainan Gold Hongye Paper Co., Ltd. (Hainan Gold Hongye)
- Hainan Gold Shengpu Paper Co., Ltd. (Hainan Gold Shengpu)
- APP China Forestry Business Unit (APP China Forestry, including Forestry Business Headquarters, Hainan, Guangxi, and Guangdong BUs, and Lancang, Wenshan, Ganzhou and Henan Sub-BUs)

As APP China completed the acquisition of Bohui Paper in July 2020, we started including relevant data from Bohui Paper in our report from our 2021 Report.

### Reporting Framework

The report has been prepared in accordance with the core option of GRI Standards (2021) issued by the Global Sustainability Standards Board (GSSB), the Global Compact Ten Principles, the TCFD recommendations issued by the Task Force on Climate-Related Financial Disclosures (TCFD), the Pulp & Paper Products standard and the Forest Management standard issued by the Sustainability Accounting Standards Board (SASB), the S&P Global Corporate Sustainability Assessment (CSA), and papermaking industry clean production and emissions standards.

### Content and Indicator Selection

This report was prepared in accordance with the GRI principles of materiality, stakeholder inclusiveness, sustainability context, and completeness, etc. At the preliminary stage, our work group conducted policy analysis, industry issues analysis, the core issues and indicators benchmark of ESG mainstream information disclosure frameworks and rating systems, stakeholder surveys, and field visits to our headquarters and pulp & paper mills to collect the management approaches, specific practices and performance indicators on sustainability/ESG issues most relevant to APP China.

### Report Assurance

APP China commissioned Technischer Überwachungs-Verein (TÜV) to assess the reliability, objectivity, and transparency of this report. Please refer to the "Assurance Statement" for further details.

### Contact Us

We sincerely welcome readers' comments and suggestions regarding this report and our work. Readers can contact us by email: [csr@app.com.cn](mailto:csr@app.com.cn).



**Sinar Mas Paper (China) Investment Co., Ltd.**

Address: 65/F, No. 501 Dongdaming Road, Hongkou District, Shanghai

Phone: +86-21-2283-8888

Fax: +86-21-2283-9063

Zip Code: 200080

Website: [www.app.com.cn](http://www.app.com.cn)

Printing paper for cover pages: CFCC/PEFC-certified Ningbo Asia *Caidie* 250g/m<sup>2</sup> double coated copper plate

Printing paper for body pages: CFCC/PEFC-certified Gold East Paper *Space Shuttle* 128g/m<sup>2</sup> double coated matte paper



Scan the QR code  
to follow us